

**Ultimate
All-in-One
Battery Charger**

**UC1240
12V 40A**

Owner's Manual

KISAESM

For safe and optimum performance, the **KISAE Ultimate Battery Charger** must be used properly. Carefully read and follow all instructions and guidelines in this manual and give special attention to the **CAUTION** and **WARNING** statements.

PLEASE KEEP THIS MANUAL FOR FUTURE REFERENCE

Disclaimer

While every precaution has been taken to ensure the accuracy of the contents of this guide, **KISAE Technology** assumes no responsibility for errors or omissions. Note as well that specifications and product functionality may change without notice.

Important

Please be sure to read and save the entire manual before using your **KISAE Ultimate Battery Charger**. Misuse may result in damage to the unit and/or cause harm or serious injury.

Product Numbers

UC1240 Ultimate Battery Charger, 12V 40A

Document Part Number

MU UC1240 Rev A.7

Service Contact Information

Email: info@kisaetechnology.com

Phone : 1 877 897-5778

Web : www.kisaepower.com

FCC and CE EMC INFORMATION

This equipment has been tested and found to comply with the limits for a Class B digital device, pursuant to part 15 of the FCC Rules and comply with the limits for CE EMC. These limits are designed to provide reasonable protection against harmful interference in a residential installation. This equipment generates uses and can radiate radio frequency energy and, if not installed and used in accordance with the instructions, may cause harmful interference to radio communications. However, there is no guarantee that interference will not occur in a particular installation. If this equipment does cause harmful interference to radio or television reception, which can be determined by turning the equipment off and on, the user is encouraged to try to correct the interference by one or more of the following measures:

- Re-orient or re-locate the receiving antenna.
- Increase the separation between the equipment and the receiver.
- Connect the equipment into an outlet on a circuit different from that to which the receiver is connected.
- Consult the dealer or an experienced radio/TV technician for help.

LIMITATIONS ON USE

Do not use in connection with life support systems or other medical equipment or devices.

WARNING: This product can expose you to chemicals, including Di (2-ethylhexyl) phthalate (DEHP) which is known to the State of California to cause cancer, birth defects or other reproductive harm. For more information, go to www.p65warnings.ca.gov

ADVERTENCIA Este producto puede exponerlo a químicos, incluyendo el ftalato de bis (2-etilhexilo) (DEHP) conocido por el estado de California como causante de cáncer, defectos de nacimiento, u otros daños reproductivos. Para obtener más información, entre a www.p65warnings.ca.gov

Table of Contents

1. INTRODUCTION	5
2. PRODUCT DESCRIPTION	5
3. UNDERSTANDING THE UNIT	5
4. INSTALLING THE CHARGER.....	9
5. UNIT OPERATION.....	12
6. SPECIFICATIONS	20
7. WARRANTY	21
Appendix A1	22

IMPORTANT SAFETY INFORMATION

This section contains important safety information for the **KISAE Utilmate Battery Charger**. Each time, before using the unit, **READ ALL** instructions and cautionary markings on or provided with the unit, and all appropriate sections of this guide. The unit contains no user- serviceable parts. See Warranty section for how to handle product issues.

WARNING: Fire and/or Chemical Burn Hazard

Do not cover or obstruct any air vent openings and/or install in a zero-clearance compartment.

WARNING: Failure to follow these instructions can result in death or serious injury. Keep away from children.

- When working with electrical equipment or lead acid batteries, have someone nearby in case of an emergency.
- Study and follow all the battery manufacturer's specific precautions when installing, using, and servicing the battery connected to the charger.
- Wear eye protection and gloves.
- Avoid touching your eyes while using this unit.
- Keep fresh water and soap on hand in the event battery acid comes in contact with eyes. If this occurs, cleanse right away with soap and water for a minimum of 15 minutes and seek medical attention.
- Batteries produce explosive gases. **DO NOT** smoke or have an open spark or fire near the system.
- Keep unit away from moist or damp areas. Never expose unit to snow, water etc.
- Avoid dropping any metal tool or object on the battery. Doing so could create a spark or short circuit which goes through the battery or another electrical tool that may create an explosion.

WARNING: Explosion hazard

- Do not use the unit in the vicinity of flammable fumes or gases (such as propane tanks or large engines).
- Avoid covering the ventilation openings. Always operate unit in an open area.
- Prolonged contact to high heat or freezing temperatures will decrease the working life of the unit.
- The **UC1240** unit is designed for use on **12V House Battery System** only. Do not use it on 24V House Battery System.

CAUTION:

- This appliance is not intended for use by persons (including children) with reduced physical, sensory or mental capabilities, or lack of experience and knowledge, unless they have been given supervision or instruction concerning use of the appliance by a person responsible for their safety.
- Children should be supervised to ensure that they do not play with the appliance.
- Do not charge non-rechargeable batteries because of the danger of eruption.
- During charging, batteries should be placed in a ventilated area.
- The battery terminal not connected to the chassis has to be connected first.
- The other connection is to be made to the chassis, remote from the battery and fuel line. The battery charger is then to be connected to the supply mains (household power).
- After charging, disconnect the battery charger from the supply mains. Then remove the chassis connection and then the battery connection.
- Examine the battery charger regularly for damage, especially the cord, plug and enclosure. If the battery charger is damaged, it must not be used until it has been repaired.

1. INTRODUCTION

Thank you for purchasing the **KISAE Ultimate Battery Charger**. With our state of the art, easy to use design, this product will offer you reliable service by providing a multi-stage, multi-input battery charger to charge the different types of batteries you have installed in either your home, boat, RV, caravan, 4WD or commercial vehicle. This manual will explain how to use this unit safely and effectively.

2. PRODUCT DESCRIPTION

- Base unit (UC1240)
- Display Panel with Connection Cable
- IEC AC Input Cord
- Owner's Manual

3. UNDERSTANDING THE UNIT

The charger is a fully automatic multi-stage, multi-input battery charger with the ability to charge from utility AC, or an alternator linked to a battery, or via solar power with its built-in Maximum Power Point Tracking (MPPT) Solar Controller. The house battery will be charged from utility AC Input as priority. When Alternator and/or Solar inputs are also available, the house battery will also be charged from either the Solar input or the Alternator input with various priority settings that include the use of the ignition start pin on the vehicle. The charger prioritizes either alternator or solar by performing custom setting and both functions are controlled from within the unit itself without the need for external relays. See more details in the **“House Battery Charging Mechanism Setting”** section on page 7.

During normal operation, the charger will do a full charge cycle on the House Battery Bank. User may select GEL, AGM, Flooded, Lithium battery or Custom Programmable settings. Once the float stage is reached, the charger transitions to a power supply mode to support any on-board DC loads. The House Battery Bank will automatically restart a new charging cycle when the set point for battery recharge is reached.

The unit provides a maximum of 80A charging current with the combination of 40A maximum through the AC Charger and 40A maximum through the DC-to-DC Charger.

Multi-stage Charging Process for GEL, AGM and Flooded Battery Types

The charger is a fully automatic, set and forget charger. It is designed to recharge your deep cycle batteries utilizing charger algorithms that help to maximize the life of your specialized deep cycle batteries.

The charger features multi-stage smart charging technology that enables the charger to be connected to your House Battery Bank permanently. With multiple input sources, you can be assured of charging your batteries everywhere via the utility AC Input, the vehicle alternators, or when the sun is shining on your solar array. Per battery manufacturer recommendations, deep cycle batteries require a multi-stage charge sequence for perfect, fast, and accurate charging. This charger delivers three primary charge stages:

Stage 1 – Bulk Charge: The battery is charged at full rated output current of the charger (as per the setting) until the battery reaches its final charging voltage, known as its absorption voltage. In this step, around 80% of the battery is recovered.

Stage 2 – Absorption Charge: With the charger voltage held steady, the remaining 20% of the battery is replenished with the charger allowing the current to taper off as the battery approaches full charge.

Stage 3 – Float Charge: In the float stage the charger voltage is lowered and held at a constant and safe predetermined level. This prevents the battery from being overcharged yet allows the charger to supply enough current to make up for the self-discharge losses of the battery, and supports any additional loads connected to the battery (such as DC lighting and refrigerators). This stage allows the charger to be used as a DC power supply.

Stage 4 – Re-Charge: When the House Battery Bank voltage drops to below the set Recharge Voltage, the charger will recharge the House Battery Bank again by switching to stage 1.

Multi-stage Charging Process for Lithium and Program Battery Types

The Battery Charger has a specific charging profile for Lithium batteries. It has its own charging voltage and current settings that need to be set by the user. The charger delivers three primary charge stages:

Stage 1 – Constant Current (CC mode): The battery is charged at the user selected maximum output charging

current (as per the setting) until the battery reaches its selectable Constant Voltage (CV) values. In this step, around 80-90% of the battery is recovered.

Stage 2 – Constant Voltage (CV mode): With the charger voltage held steady, the remaining 10-20% of the battery is replenished with the charger allowing the current to taper off as the battery approaches full charge. This can take anywhere between 3 to 25 minutes and is dependent on the capacity (size) of the battery bank, the Constant Voltage setting and the battery's initial state of charge.

Stage 3 – Terminate/Float: It requires the user to set the charger termination current ("L" setting) to decide when to terminate the charging process. Once the charging current drops to the set termination current, the charger will then act as a power supply to support additional loads connected to the battery. This power supply voltage is known as float voltage and is also user selectable.

Stage 4 – Recharge: When the House Battery Bank voltage drops to below the set values (Recharge Voltage), the charger will recharge the House Battery Bank again by switching to stage 1.

Smart Charging Feature

In Stage 3 the charger will regulate its output based on the loads connected to your House Battery Bank. This function is important to maintain the life of your battery banks as some other battery chargers mistake loads for discharge and continue to keep the batteries in the bulk or absorption stage for extended periods of time, causing damage to the battery bank.

House Battery Bank Charging Algorithm (4 stages)

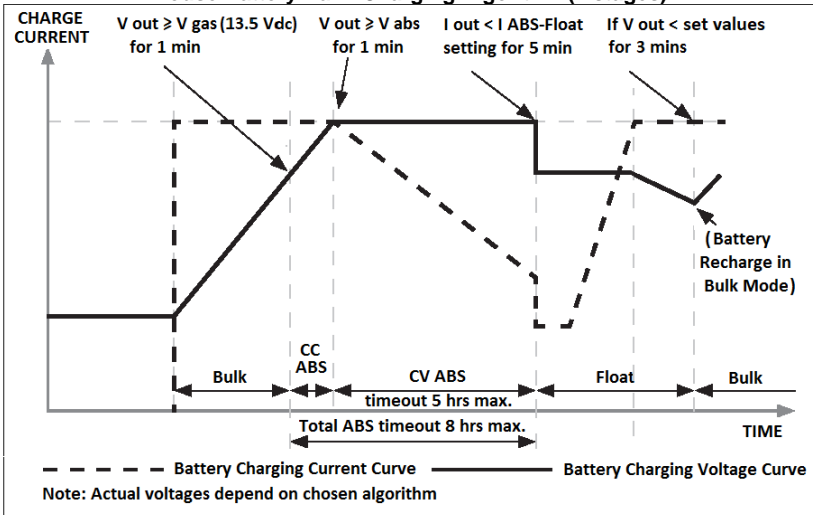

House Battery Bank (CH1) Charging and Recharging Voltage Setting

WARNING: FIRE HAZARD. When choosing the battery type, double check that the charging voltage setting matches with the recommended charging voltage from the battery manufacturer. Using the wrong values may overcharge and damage the battery and may cause a fire.

Battery Setting Type	Charging Voltage Setting		
	Bulk/Absorption	Float	Recharge Voltage
GEL	14.4V	13.7V	12.8-13.5V (0.1V step)
AGM	14.6V	13.6V	12.8-13.4V (0.1V step)
Flooded (Note 2)	14.4V	13.3V	12.8-13.1V (0.1V step)
Lithium (Note 3)	13.9-14.6V (0.1V step)	13.5-14.4V (0.1V step)	12.8-13.8V (0.1V step)
Program - Custom Settings (Note 3)	13.9-14.6V (0.1V step)	13.5-14.4V (0.1V step)	12.8-13.8V (0.1V step)

Note 1: The House Battery Bank will automatically start a full recharge cycle again when the battery bank terminal voltage drops to below the recharge voltage.

Note 2: Battery Equalization setting is available for Flooded batteries. Equalized voltage is set to 15.5V on a 12V battery bank system. See more details on "Procedure to Equalize the Flooded Battery" on page 12.

For Concorde™ branded batteries (Lifeline, Sun Xtender) use flooded setting and consult battery supplier for equalization recommendations.

Note 3: The Charging Voltage and Float Voltage setting for Lithium battery or for Program – Custom voltage setting are user selectable. Consult the battery manufacturer for the maximum allowable charging voltage and the float stage voltage after the battery is fully charged. The Float voltage and Recharge Voltage can only be set to at least 0.2V below the Bulk/ Absorption voltage and the Float voltage respectively.

Choose the Current Setting for GEL/AGM/Flooded Battery Type

The Bulk/Absorption (Bulk/Abs) and Absorption-Float (Abs-Float) Stage current settings are based on the House Battery Bank size. Typically, and for maximum lifespan of the sealed and non-sealed lead acid battery banks, it is recommended the maximum Bulk/Abs ("H") current setting should not be more than 1/5 of its total capacity in Ah (e.g. select 40A or lower when a 200Ah battery bank is used).

Battery Bank Size vs Charging Current Setting				
Minimum Battery Bank Size used in Ah	100	200	300	400 or higher
Maximum Current Setting "H" in A	20	40	60	80

Once the Bulk/Abs ("H") current is selected, the Abs-Float Stage ("L") current can be selected. It is recommended to select 1/10 of the Bulk/Abs current as the Abs-Float stage current setting.

Available GEL, AGM, Flooded, Program Battery Type Current Setting				
Bulk/Abs ("H") in A	20	40	60	80
Abs-Float ("L") in A	2/4/6	4/6/8	4/6/8	4/6/8

Note: If a DC load is always ON and connected to the battery bank, a higher Absorption-Float charging current is recommended. If in doubt about the "L" setting, use the highest available current setting for battery protection. The Absorption-Float current can be selected to determine when to start passing to the Float stage (with 3 stages setting) or to terminate the charging process (with 2 stages setting).

Choose Current Setting for Lithium Battery and Program-Custom Setting Type

WARNING: FIRE HAZARD. When choosing the Lithium Battery or Program-Custom Setting type, a wide range of charging currents are available. Consult the battery manufacturer for the maximum allowable charging current. Using charging current higher than the allowable charging current may result in damaging the battery and may cause a fire.

The Charging Current and Termination Current are user selectable and are based on battery bank size. Consult the Lithium battery manufacturer for the maximum allowable charging current before setting the Charge Current ("H"). The Termination Current ("L") can be selected to determine when to start passing to the Float stage.

The Bulk stage on a Lithium battery is also named Constant Current (CC) Stage and the Absorption Stage on a Lithium battery is also named Constant Voltage (CV) Stage.

Available Lithium Battery Current Setting (A)				
Charge Current ("H")	20	40	60	80
Termination Current ("L")	2/3/4	4/6/8	4/6/8	4/6/8

Note: If a DC load is always ON and connected to the battery bank, a higher Termination Current is recommended. If in doubt about the "L" setting, use the highest available current setting for battery protection.

House Battery Charging Mechanism Setting

The house battery can be charged from the AC charger alone (40A maximum) and from the DC charger alone (40A maximum) through the Solar or the Alternator Input. When both the AC input source for the AC Charger and the DC input source for the DC Charger are available, the maximum charging current to the House battery can be up to a maximum of 80A.

The following chart shows how AC Charger and DC Charger charging current contribute to charging the House Battery with the various Maximum Current Settings.

Maximum Current Setting	Maximum Charging Current with the availability of AC and DC Charger		
	Only AC is available	Only DC is available	Both AC and DC are available
80A	40A	40A	80A total (40A from AC, 40A from DC Chargers)
60A	40A	40A	60A total (shared between AC & DC Chargers)
40A	40A	40A	40A total (40A from AC)
20A	20A	20A	20A total (20A from AC)

If both AC source and DC sources are available, there is no preset priority charging to choose between the use of the AC Charger and the DC Charger. The charging current can be from either the AC Charger or the DC Charger. During the Absorption stage, if the demand on the charging current is lower than the current setting, the charging current can be supplied from either the AC Charger or the DC Charger, or both chargers.

There are 6 user selectable settings for the DC Charger. Choose the appropriate setting that fits the needs:

P1 (Alternator Input with Ignition Start signal as high priority): The unit house battery will be charged from Alternator Input when ignition start signal is provided and is in operating range. If Ignition Start signal is not provided or if Alternator Input is out of operating range, the house battery will switch to charge from Solar Input if it is available and in operating range.

P2 (Solar Input as high priority): The house battery will be charged from Solar Input when it is in operating range. When Solar Input is not available, the house battery will switch to charge from Alternator Input if it is available and in operating range. The Ignition Start pin signal is ignored in this setting.

P3 (Alternator Input without Ignition start as high priority): The house battery will be charged from Alternator Input when it is in operating range. When Alternator Input is not available or out of the operating range, the house battery will switch to charge from Solar Input if it is available and in operating range. In this operating mode, the Ignition Start pin signal is ignored.

P4 (Solar Input only): The house battery will be charged from Solar Input only. The DC charger will not switch to charge from Alternator Input even the Solar Input is not available or out of operating range.

P5 (Alternator Input with Ignition-Start only): The house battery will be charged from Alternator and with Ignition-start signal only. The DC charger will not switch to charge from Solar Input even the Alternator Input is not available or out of operating range or Ignition-start signal is not available.

P6 (Alternator Input only): The house battery will be charged from Alternator only. The DC charger will not switch to charge from Solar Input even the Alternator Input is not available or out of operating range.

See more details in the chart below on how the DC Charger will operate with different priority settings under various conditions.

Unit Setting	Solar Input	Alternator Input	Ignition Start Port	Charging Mode
P1 (Alternator Priority with Ignition Start signal)	In or out of range	In range	High Signal	Alternator
	In range		No Signal	Solar
	Out of range			No Charge
	In range	Out of range	With or Without Signal	Solar
	Out of range			No Charge
P2 (Solar Priority)	In range	In or Out of range	With or Without Signal	Solar
	Out of range	In range		Alternator
		Out of range		No Charge
P3 (Alternator Priority without Ignition)	In or out of range	In range	With or Without Signal	Alternator
	In range	Out of range		Solar
	Out of range			No Charge
P4 (Solar only)	In range	In or Out of range	With or Without Signal	Solar
	Out of range			No Charge
P5 (Alternator with Ignition Start only)	In or Out of range	In range	High Signal	Alternator
			No Signal	No Charge
		Out of range	High Signal	No Charge
			No Signal	No Charge
P6 (Alternator Only)	In or Out of range	In range	With or Without Signal	Alternator
		Out of range		No Charge

4. INSTALLING THE CHARGER

Unit System Diagram

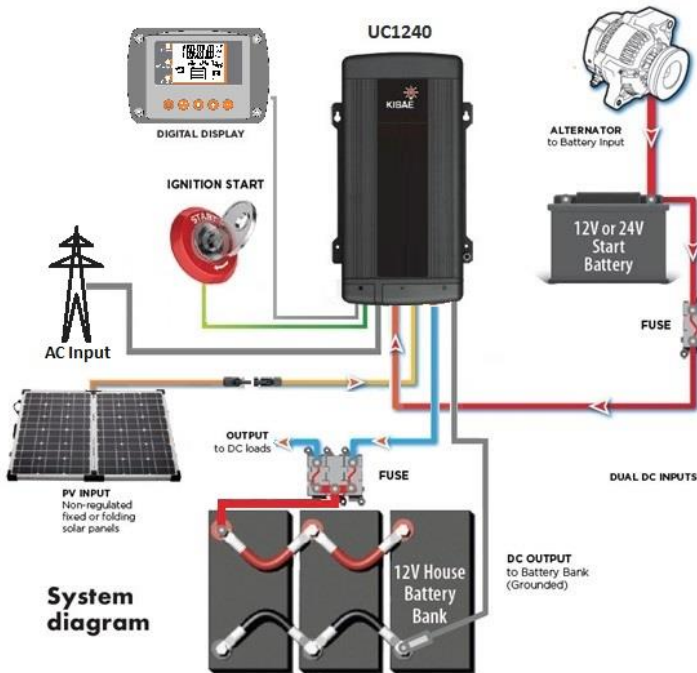

Note: This diagram is for reference only. No cables, fuse/breakers, batteries, or solar panels are supplied with this unit. Local rules and regulations should be followed when installing this unit.

WARNING: KISAE Technology recommends that all wiring be done by a certified technician or electrician to ensure adherence to the applicable electrical safety wiring regulations and installation codes. Failure to follow these instructions can damage the unit and could also result in personal injury or loss of life.

CAUTION: Before beginning your unit installation, please consider the following:

- The unit should be used or stored in an indoor area away from direct sunlight, heat, moisture, or conductive contaminants.
- When placing the unit, allow a minimum of three inches of space around the unit for optimal ventilation.

Mounting the Charger:

- Choose an appropriate mounting location.
- For installing in an indoor location, the unit should be mounted vertically (with the battery terminals facing downwards). This provides the best thermal performance and drip protection. The unit should NOT be mounted upside down.
- For installing in a boat or marine environment, the unit should only be mounted vertically (Battery Terminals facing downwards) to provide adequate drip protection.
- Use the base of the charger as a mounting template to mark the positions of the screws.
- Drill the 4 fixing holes and place the Charger in position and fasten the unit to the mounting surface.

Note: The charger is designed to be permanently mounted.

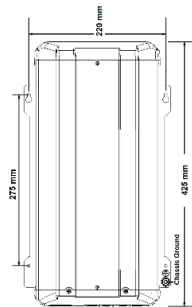

Wiring the Charger:

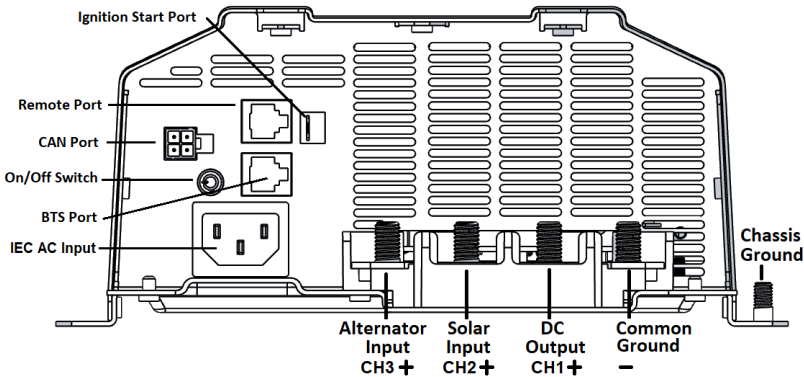

Chassis Ground Stud Connection:

DANGER: The unit chassis has to be grounded properly. Never operate the Charger without proper grounding. Failure to do so will result in death or serious injury. Ground connection to the charger must comply with all local and application-specific codes and ordinances.

Connect the unit's chassis ground to the common ground point in the system through the "Chassis Ground" stud located on the rear of the unit.

DC Inputs (Alternator & Solar), DC Output, Common Ground Wiring:

WARNING: The DC wiring used must be of an appropriate size. An individual over-current protection device such as a fuse or circuit breaker usually within 7 inches (17.8cm) of each battery bank is required. A DC disconnect switch is also recommended. Both devices must be rated for DC voltage and current to withstand the short circuit current available from the connected battery bank. Both devices must match the size of the DC wiring.

Recommended Cable Length, Size and Fuse Protection:

- Use the following chart to determine the recommended fuse and wire size connection for Alternator Input (CH3) and House Battery Output (CH1) based on < 5ft wire length.

Unit Connection	Fuse/Circuit Breaker size	Wire Size
CH 1 House Battery Bank	80 A	AWG #2, 34mm ²
CH 3 Alternator Input (12V system)	60 A	AWG #4, 25mm ²
(24V system)	30 A	AWG #6, 16mm ²

Note: Keep the connection between the House Battery bank and CH1 as short as possible.

- Use the following chart to determine the recommended fuse and wire size connection for Solar Input (CH2) based on < 20 ft wire length and solar panel size configuration.

Solar Panel Size	1 panel	2 panels	3 panels
12V 200W	15A, 10AWG	30A, 6AWG	40A, 6AWG
24V 200W	10A, 10AWG	15A, 10AWG	30A, 6AWG
12V 400W	30A, 6AWG	50A, 4AWG	N.A.
24V 400W	15A, 10AWG	30A, 6AWG	N.A.

Note: The solar panel size listed on the chart above is for reference only. The fuse size, cable length and wire gauges vary with the solar panel size accordingly. Please consult the solar panel manufacturer for wiring details. The rule of thumb for selecting a fuse, is to add 10-15% to the total short circuit current the solar panel can provide. The wire size will be based on the fuse used.

- Detach the plastic cover of the DC wiring compartment by removing the two screws on its top.
- Connect the CH1 "+" terminal in series to one of the over-current protection devices, the disconnection device, and finally to the "+" terminal of the House Battery bank.
- Connect the unit's "Common Ground" port to the negative terminal of the House Battery Bank or the "Common Ground" point of the system.
- Connect the vehicle's alternator or the starter battery's positive terminal to the unit's CH3 "+" port and the negative terminal to the unit's "Common Ground" port.

- Connect the solar array's positive terminals to the unit's CH2 "+" port and the negative terminal to the unit's "Common Ground".
- Tighten all the bolts of the charger terminals to 4.0-5.0 N-m (35-45 lb-in) of torque. Do not over-tighten as this may result in damage to the charger.
- Replace the plastic cover to its original position and secure the two screws on its top.
Note: Negative wires of CH3, CH2, CH1 are connected at "Common Ground" port of the unit.

Remote Port Connection

- Connect the provided Display to the "Remote" port on the unit through the provided RJ12 cable and connect the other end of the RJ12 cable to the "Remote" port at the back of the remote.

Battery Temperature Sensor (BTS) Port Connection

- To install the Battery Temperature Sensor (BTS), sold separately, simply connect the RJ12 plug from the sensor to the 'BTS' port on the unit.
- Connect the other end the temperature sensor (ring terminals/lug) to the negative terminal of the main house battery bank.

Ignition Start Port Connection (required for P1 and P5 setting use only)

- Connect the Ignition Start signal from the vehicle to the Ignition Start port on the unit.
- This connection is required for DC Charger Priority setting P1 and P5 use only.
- For P1 and P5 setting on DC Charger operation, see more details in "*House Battery Charging Mechanism Setting*" on page 7.

CAN Port Connection (optional)

- Communication port for use with CANBUS communication system.

CAN Connector (on unit)

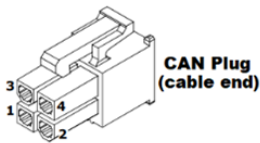

Pin	Designation
1	Not Connected
2	CAN Low
3	CAN High
4	Not Connected

5. UNIT OPERATION

Unit ON/OFF

There are three ways to turn ON the unit:

- **Using the unit **Power** push button switch located on the main unit and on the Display Panel:**
Press and hold the green **Power** push button switch on the main unit or '**Power**' push button switch on the Display Panel for approximately one second to activate the charger. When the unit is not in use, press and hold the **Power** switch on the main unit or the '**Power**' push button on the Display Panel until the display shows '**PWR OFF**' to turn unit off. These two power switches share the same function to control the unit on/off. They are not the power switches to disconnect the power connection to AC Input of the AC Charger and the two DC Inputs of the DC Charger.
- **Using the Ignition Start Port:**
The unit can also be turned ON by using the positive rising edge on a > 8V voltage signal provided to the Ignition start signal. After the unit is turned ON, the unit will remain ON even if the signal is removed.
- **Using the Solar Input Port (CH2):**
The unit can also be turned ON by providing a > 20v signal to the solar input port (CH2).

There are two ways to turn OFF the unit:

- **Using the **Power** push button on the main unit or on the Display panel:**
Press and hold the **Power** push button switch for approximately one second or on the Display panel to turn OFF the charger. The **Power** switch is a signal switch and not a main power switch to disconnect the connections between the DC Inputs and the DC Output of the unit.
- **Using the **Automatic Unit OFF** function:**
With AC utility input not available and when charger senses both CH2 and CH3 input are out of operating range or not available, the unit will automatically turn OFF in 3 minute to avoid the sustained current being drawn from either the house battery or the alternator battery.
Note: If the 'Ignition Start Port' is connected with high voltage signal, both the **Power** push button and the **Automatic Unit OFF** function cannot be used to turn the unit OFF.

Understanding the Charging Mechanism

The Charger is powered by the battery connected to the House Battery or by the AC Input connected to the AC Power source. If No AC Power source is available, the unit requires a minimum of 8Vdc from the House battery to operate.

Operating from an Alternator/ Starter Input (CH3)

The CH3 DC Input (Alternator/Start Battery Input) will accept a 12V or a 24V Input battery with an alternator system. When the unit is first connected, the unit will measure the input voltage. If the voltage is > 17V, it will assume it is connected to a 24V Input Battery/Alternator system. If the voltage detected is < 17V, it will assume it is connected to a 12V Input Battery/Alternator system. Once detected, it will store this into the microprocessor, and it will only be erased if the Input battery is disconnected or if the measured Input Voltage drops to < 7Vdc.

Normal Operation	Alternator/Starter Input (CH3)	
	12V INPUT Source	24V INPUT Source
Input Voltage Range	10.5 – 16.0V	21.0 – 32.0V
Start-Up Voltage CH3 setting (Note A)	11.5 – 13.8V	25.4 – 27.4V
Under Voltage Recovery Voltage (Note A)	0.4V below Normal Start-Up Voltage	0.8V below Normal Start-Up Voltage
De-Rated Voltage (with load) (Note B)	11.5V	23.0V
Under Voltage Shutdown Voltage (with load) (Note B)	10.5V	21V
Over Voltage Shutdown	16.0V	32V
Over Voltage Recovery	15.5V	31V
Input Battery System Reset Voltage (Note C)	< 8V	< 8V
Maximum Input Current (CH3)	50A	50A

Note A: This voltage setting determines the start-up voltage for charging the house battery through the alternator. This setting is for use with P1, P3, P5 and P6 only. Once this threshold is met, the house battery will start charging from the alternator. If the alternator voltage drops to below the '**Under Voltage Recovery Voltage**', the charger will go to an Alternator Input Voltage checking process. It will start to charge for 3 minutes and then stop charging for 5 seconds. By the end of 5 seconds, the unit will check CH3 voltage. If the voltage rises to above the '**Under Voltage Recovery Voltage**', it will carry on charging the House battery. But if the voltage does not rise to above the '**Under Voltage Recovery Voltage**', it will terminate the charging process and depending on the priority setting, the House battery may switch to charge from CH2 solar input or charge again from the alternator if the alternator voltage bounces back to above the '**Start-Up Voltage**'.

Note B: During the 3 minutes charging process, if the measured CH3 terminal voltage drops below the **Under Voltage de-rating voltage** (11.5V for a 12V Input system or 23V for a 24V Input system), the charger will start to de-rate the output current. This function is used to compensate for the use of long or thin wire between the Alternator Input Battery System and the unit terminals. If the input voltage continues to drop below the **Under-Voltage Shutdown Voltage** (10.5V for a 12V Input system and 21V for a 24V Input system), the charging process from CH3 will be terminated. Depending on the priority setting, the House battery may switch back to charge from CH2 solar input or charge again from the alternator once the alternator voltage bounces back to above the **Start Up Voltage**.

Operating from an PV Solar Array/ Panel (CH2)

The DC charger limits the input current of CH2 to 40A maximum. If a 12V solar panel is used, with maximum charging current setting charging from the solar input, the maximum solar input power required is around 600W with 40A input current. If two 12V solar panels are used and connected in series, the maximum input current is around 20A. In consideration of the power available through the solar panel during a cloudy (or intermittent sunny) day to harvest more solar energy, you can however “overdrive” the MPPT controller. Please note that doing this is partially an economic decision. You can install more power than the controller can use, and this will contribute to better power availability. We suggest a total maximum overdrive of 20% (total 720w).

Normal Operation	PV Solar Array/Panel (CH2)
PV Input Voltage Range	14.5 - 55V
PV Input Under Voltage Shutdown	< 14.5V
PV Input Under Voltage Recovery	15.0V
PV Input Over Voltage Shutdown	> 55.0V
PV Input Over Voltage Recovery	≤ 48.0V
PV Charging Mechanism	MPPT type (approx. 97% efficiency)
Maximum Input Current	40A (*Note)

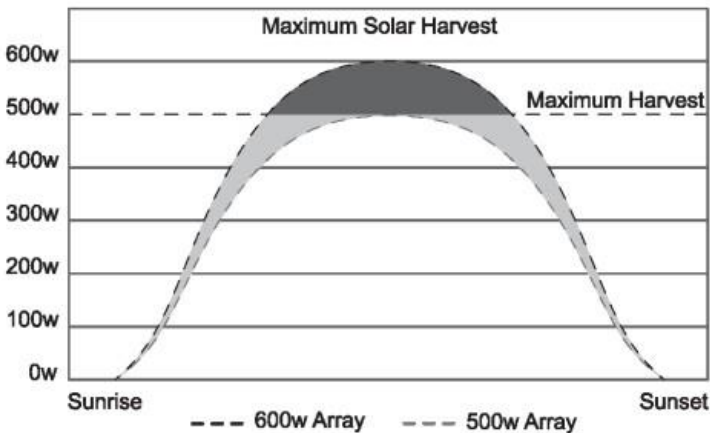

Trickle Charge Alternator battery (CH3) by Solar Power (CH2) 'STC'

This unit comes with a unique reverse charging feature that uses CH2 Solar Power to trickle charge the Alternator battery connected to CH3. This function will only work with **P4** (Solar Input Only) setting.

To activate this function, go to '**STC**' setting function, press **Menu Set** once and use the **Up** and **Down** buttons to select the desired setting. See more details in Section 6 in Appendix.

'**OFF**': The trickle charge function is disabled.



'**ON**': The trickle charge function is enabled.

Restarting a latched Lithium Battery or a dead SLA battery 'SIL'

The unit also comes with a unique manual startup charging mechanism to reset a Lithium battery that has been latched off by the internal BMS inside the Lithium battery due to under voltage shutdown or other fault condition. This function is designed to be used with Lithium battery setting only. To activate this function, go to unit setting mode and set '**SIL**' function to On. It will provide 12V 1A charging current to CH1 House battery for 30 seconds. When the process is finished, the unit will automatically switch Off and the unit will go back to normal operation. If the Lithium battery is still in a latched off condition, check the Lithium battery and then restart the startup charging mechanism if needed or consult the battery manufacturer for instructions on starting a latched Lithium battery.

In case the SLA House Battery connected to CH1 is discharged to below 8V, the battery charging function may not function normally. In case this happens, temporarily change the battery to Lithium type and use the above procedure to activate the SIL function. Once finished, please be sure the battery type is changed back to the original battery type.

Understanding the Display function during normal operation

Digital Display	
CH1	Display shows House battery's battery information voltage (V), charging current (A), charging status (BUL – Bulk stage, Flo – Float stage)
CH2	Solid: PV input CH2 is charging the house battery
	Flashing: CH2 is in standby, PV input CH2 is available and is in operating range. The house battery is charging from the other channel
	Off: CH2 is out of operating range or is not connected.
CH3	Solid: Alternator input CH3 is charging the house battery
	Flashing: CH3 is in standby, Alternator input CH3 is available and is in operating range. The house battery is charging from the other channel with higher priority, or the ignition start signal is not available with P1 setting.
	Off: CH3 is out of operating range or is not connected.
	Solid: PV input CH2 is charging the house battery
	Solid: Alternator input CH3 is charging the house battery
	Solid: AC Charger is charging the house battery
DC OUTPUT	Solid: DC Output is available and is charging the battery voltage
AC INPUT	Solid: AC Input is available and is charging the house battery

- During normal operation with house battery charging being in place, the display shows alternately the House Battery Bank Voltage (V), Charging Current (A) and Charging Stage Status ('bul' = Bulk, 'Abs' = Absorption, 'Flo' = Float) of the CH1 output.
- If the other input channel 'CH3' or 'CH2' is available and its voltage is in its corresponding 'Start-Up' voltage threshold, the icon will be flashing.
- When 'AC to Battery' icon is ON, it indicates the AC utility input is available and is charging the house battery.

Understanding the Push Buttons Functions on Display Panel



Power	To turn unit ON, press ' Power ' button on main unit or on remote. To turn unit OFF, press and hold ' Power ' button on the main unit or the remote for about 3 seconds, display will show ' PWR - OFF ' and shutdown.
Menu Set	In normal operation, Press ' Menu Set ' for about 3 seconds to enter <i>parameter display mode</i> . The display shows the following parameters. Use Up and Down button to toggle between parameters. <ul style="list-style-type: none"> • 'PRI' (priority setting), follow with the existing setting ('P1' to 'P6') • 'bAT' (Battery type): 'AGM'/'GEL'/'Flooded'/'Lithium'/'Program' • 'CH3' (Alternator Start-Up voltage): 11.5 to 13.8V and 23 to 27.6V • 'STC' (Trickle charge from PV to Alternator): OFF/ON • 'SIL' (Restart a latched Lithium battery): OFF/ON • 'MFD' (Manufacturing Default Setting): PRI - P3, Bat - Li, BUL - 14.4V, Flo - 14.0V, REC - 13.5V, H80A, L8A, CH3 -13.2V, STC - OFF, SIL - OFF. <p>With individual settings, press 'Menu/Set' again to enter <i>setting change mode</i>. The selected setting will be shown on the display. Use 'Up' and 'Down' to toggle between available settings. Press 'Menu/Set' to confirm the new setting.</p>
Up / Down	<ul style="list-style-type: none"> • Use to toggle between parameters in parameter display mode. • Use to toggle between settings in setting change mode.
Escape	To exit parameter setting mode.

Understanding Three-Stage (Mode 3), Two-Stage (Mode 2) Charging for GEL, AGM, Flooded battery & Program Mode battery

The Three-Stage Charging (Mode 3) consists of Bulk, Absorption and Float stages. During the Bulk stage, the house battery (on CH1) accepts the maximum constant current from the charger as per the setting. In the Absorption stage, the battery voltage is held to constant voltage and the charging current will slowly reduce. In Float stage, the charger continuously produces lower constant float voltage to fully top up and maintain the battery in a fully charged state. The charger will automatically restart the full charging cycle if it senses the battery bank is discharged to lower than the Recharge battery voltage setting.

The Two-Stage Charging (Mode 2) has only Bulk and Absorption charging stages. Charger will terminate battery charging once it reaches the Absorption to Float ("L") current setting. The charger will automatically restart the full charging cycle if it senses the battery bank is discharged to lower than the Recharge battery voltage setting.

Manual Battery Temperature Compensation Setting (GEL, AGM, FLOODED, BATTERY ONLY)

There are three manual battery temperature settings on the unit ('Low', 'nor' and 'hi'). Select the proper setting based on the room temperature as per the following table. The unit can provide a more accurate and automatic temperature compensation when the optional Battery Temperature Sensor (BTS) is in used. See more details in the Automatic Battery Temperature Compensation using the BTS section below.

Temperature Setting	Existing Battery Room Temperature	Battery Type	Voltage adjustment from 25°C normal setting
Low (Low)	< 5°C	GEL, Flooded	+0.675V
		AGM	+0.525V
Normal (nor)	> 5°C and < 30°C	GEL, Flooded, AGM (always for Lithium)	0V
			0V
High (hi)	< 30°C	GEL, Flooded	-0.270V
		AGM	-0.210V

Automatic Battery Temperature Compensation using the BTS (GEL, AGM, FLOODED, BATTERY ONLY)

The Battery Temperature Sensor (BTS) is an optional accessory for the charger to protect your battery and provide better charging voltage accuracy, by making small adjustments to it, based on the temperature measured directly on the battery. No special setting is required. The unit automatically detects when the sensor is plugged into its corresponding "BTS" port located in the DC wiring compartment, and overrides the manual temperature setting (i.e. "Low", "Nor", and "Hi"). It is highly recommended that the BTS to be installed on the main battery bank negative terminal.

With this optional feature, the charging voltage is automatically adjusted as per the following table.

Measured Battery Temperature	Automatic Battery Charging Voltage Adjustment from 25°C	
	Flooded and GEL type	AGM type
< 25°C	+0.027V / °C	+0.021V / °C
25°C	0V	0V
> 25°C	-0.027V / °C	-0.021V / °C

Additionally, the BTS allows the triggering of the E07 and A02 messages corresponding to the battery over-temperature shutdown and alarm, respectively.

When the optional BTS is in used with Lithium Battery setting, there is no voltage compensation on the charging voltage. The unit will shut down the charging process when it senses the battery temperature is falling to below 0C or above 50C. It will resume the battery charging process automatically when it senses the Lithium battery temperature rising to above 5C or dropping to below 45C.

Procedure to Set or View Charger Setting

Follow the procedure or sequence in Appendix to view or change setting on the unit.

Procedure to Equalize Flooded Battery

DANGER: Explosion Hazard. The battery generates explosive gases during equalization. Follow all the battery safety precautions listed in battery manual.

DANGER: Explosion Hazard and Risk of Battery damage. When using the equalization mode, the user has to be sure the battery connected to the channel is a flooded battery type. Equalizing a non-flooded battery may overcharge the battery and may cause the battery to explode.

CAUTION: Risk of Battery and Equipment damage. Only Flooded lead-acid batteries can be equalized. Consult your battery manufacturer or read the battery manual when you try to equalize your batteries. Disconnect any DC load connected to the battery, as during equalize mode, the charger will produce 15.5V on 12V model, or 31.0V on 24V model, to the batteries. You must monitor the battery-specific gravity throughout the equalization process to determine the end of the equalizing cycle.

Note: The equalization function although included in the unit will rarely be used. To activate, the battery bank must be in float stage, and stage activation is performed manually. A typical vehicle may not provide enough time for the unit function to complete the process. The MPPT Solar function may provide enough time for Equalization, but the best recommendation will be using an AC powered battery charger. KISAE does manufacture a line of smart AC battery chargers, please consult www.kisaepower.com.

Before setting the equalization mode, please be sure the battery is a flooded battery type, and the battery type is set to Flooded type.

To equalize the flooded battery, go to settings and change 'Eq' from OFF to ON. The charger will automatically fully charge the battery bank and will then follow with 1 hour of equalization. Check the battery electrolyte level during the equalization period. If necessary, refill with distilled water only. All cells should have similar electrolyte levels. If distilled water is added, batteries must undergo a complete charge cycle. Because the charger cannot determine when to terminate the equalization of the battery, a one hour time-out is set and this is used as a safety feature to require the user to continually re-activate it as necessary after checking batteries manually. Please note the battery mode setting has to be set to 'Flooded' battery type in order to have this function activated. To deactivate the equalization on flooded battery, go to settings and change 'Eq' from ON to OFF.

Understanding the Display Codes and the Protection Features.

Codes will show on the display when either a function or internal warning / fault, such as high internal temperature or DC out-of-range is detected, and the charger may shut down to protect itself until the fault has cleared. See table description below for more information.

Code	Description
bUL	The charger is in Bulk Charging Stage Bulk or Boost charge: The battery is charged at full rated output current of the charger until the battery reaches its final charging voltage, known as its absorption voltage. For SLA or Flooded battery type, the battery is charged to approximately 80% of its capacity. For Lithium battery type, the battery is charged to approximately 90-95% of its capacity.
Abs	The Charger is in Absorption Charging Stage Absorption charge: With the charger voltage held steady, the remaining battery capacity will be topped up during this stage to full battery capacity.
FLo	The Charger is in Float Charging Stage Float Charge: In the float stage the charger voltage is lowered and held at a constant and safe predetermined level. This prevents the battery from being overcharged yet allows the charger to supply enough current to make up for the self-discharge losses of the battery, while supporting any additional loads connected to the battery (such as DC lighting and refrigerators). This stage allows for the charger to be used as a DC power supply.
CHE	CH3 Input Voltage Check This is displayed for 5 sec. every 3 minutes when charging from the CH3 Start-Battery/Alternator input. It occurs when the CH3 Input Voltage is 0.4V below the CH3 startup voltage. During this 5 sec. checking period, the CH3 is internally disconnected to check its voltage and to decide if it meets the corresponding Under-Voltage-Recovery-Voltage. See more details on Section 5 "Operating from an Alternator/Starter Input (CH3)"

Error Code for DC Charger	
E01 (CH2/CH3 flashing)	<p>CH3 High Input Voltage Shutdown with CH3 available only The unit has detected that the CH3 Start/Alternator input has gone above 16.0V on a 12V input battery or 32.0V on a 24V input battery. This error will clear once the input has dropped below 15.5V on a 12V battery input or 31.0V on a 24V battery input.</p>
E02 (CH2/CH3 flashing)	<p>CH3 Low Input Voltage Shutdown with CH3 available only The DC Charger section has detected that the input from the CH3 Start/Alternator has gone between 8 to 10.5V on a 12V battery input or 16 to 21V on a 24V battery input. This error will clear once the input has risen above the Low or Normal Start-Up voltage.</p> <p><i>If you have this error:</i></p> <ul style="list-style-type: none"> • Confirm the voltage of your CH3 Start Battery is above the corresponding Start-Up voltage • Check that your alternator is running properly. • Check that the battery cable from the Start Battery is properly sized, to avoid excessive voltage drop. • Make sure there are not any loose terminals or blown fuses. • Check if there are DC loads drawing current from the CH3 Start battery, resulting in a net discharging current.
E03 (CH2/CH3 flashing)	<p>CH2 High Input Voltage Shutdown with CH2 available only The input from the CH2 Solar input has gone above 55V. This error will clear once the input drops below 52V.</p> <p><i>If you have this error:</i></p> <ul style="list-style-type: none"> • Check the specification of your panels – the Volts Open Circuit (VOC) should not exceed 55Voc. • If having panels in series for 24V nominal, make sure its voltage in open circuit (Voc) does not exceed 55V when having maximum sunlight condition. Otherwise, consider connecting the solar panels in parallel (i.e. + to + and - to -) for a 12V nominal panel array.
E04 (CH2/CH3 flashing)	<p>CH2 Low Input Voltage Shutdown with CH2 available only The DC Charger section has detected the input from the Solar Array between 10 to 14V.</p> <p><i>If you have this error: This is not necessarily a malfunction.</i></p> <ul style="list-style-type: none"> • Check that you are not in a low light/non- direct sunlight situation i.e. early morning /late afternoon, or even at night. • This may also happen if your solar panels are inside of a shed with a skylight or outside under Flood Lights. <p>If you find this is happening with your unit when stored, we recommend fitting a DC breaker to the output of the Charger and turning it off when the unit is not in use.</p>
E05 (CH2/CH3 flashing)	<p>CH1 High Input Voltage Shutdown This means the unit has detected that the CH1 Main/House battery has gone above 16.0V This error will clear once the input has dropped below 15.5V. This may be due to the house battery being charging from another external charging source, and it has charged the House battery to above the threshold.</p>
E06 (CH2/CH3 flashing)	<p>Over Temperature Shutdown When the DC Charger section's internal temperature rises above 65°C, the charger will shutdown. It will recover automatically when the environmental temperature drops below 40°C.</p> <ul style="list-style-type: none"> • Check to make sure the fan is working. • Make sure the unit has good ventilation.
E07 (CH2/CH3 flashing)	<p>BTS Over Temperature Shutdown This means the Battery Temp Sensor has detected that the batteries are too hot > 60°C and have shut down to not over charge the batteries. The unit will return back to normal charging once the battery temperature sensor is < 56°C.</p> <p><i>If this occurs, check the temperature of the batteries.</i></p> <ul style="list-style-type: none"> • If the Batteries are Hot – you may have a dropped cell or faulty battery. Stop all charging and see your local battery shop to get your batteries tested. • Check the batteries and the charging current. The charging current may be set too high. • If the Batteries/Terminals are still cool or only warm, you may have a bad temp sensor. Unplug the temp sensor and contact KISAE.

Warning Code for DC Charger	
A01 (CH2/CH3 flashing)	<p>Over Temperature Warning When the charger's internal temperature is > 60°C, the unit will show 'A01'. If the ventilation of the unit is not improved, it will lead to 'E06'- Unit Over Temperature Shutdown. The 'A01' warning code will disappear when the internal temperature drops to < 58°C.</p> <ul style="list-style-type: none"> • Check if there is an object blocking the air ventilation of the unit. • Check if the fan is working. • Make sure the unit has good ventilation.
A02 (CH2/CH3 flashing)	<p>BTS High Temperature Warning When the battery temperature sensor is > 58°C, the display will show 'A02'. If the ventilation of the battery environment is not improved and the temperature continuously rises, it will lead to 'E07'- BTS Over Temperature Shutdown. The 'A02' warning code will disappear when the measured temperature drops to < 56°C.</p> <ul style="list-style-type: none"> • Check the batteries and the charging current. The charging current may be set too high. • Make sure the batteries have good ventilation.

Error Code for AC Charger	
E02 (AC Input flashing)	AC Input has been detected <85Vac and AC Charger section is with low AC Input Voltage shutdown. Check that the AC Input voltage is above 100Vac.
E03 (AC Input flashing)	CH1 House battery DC Output is connected in reverse. Check the CH1 DC Output connection. Reconnecting the CH1 DC output wires is required.
E04 (AC Input flashing)	AC Input Charger has detected that the internal section has over temperature shutdown. Check the ambient temperature or if any ventilation opening is blocked by any object. Check to make sure the fan is working.
E06 (AC Input flashing)	AC Input Charger has detected the BTS temperature is running at high temperature and has shut down the battery charging. Check House battery temperature.
E09 (AC Input flashing)	AC Input charger has detected AC Input Voltage high and has shutdown. Check the AC Input source and make sure the AC Input source provided is within the operating range of the unit.

6. SPECIFICATIONS

Note: Specifications are subject to change without notices.

Output Rating	UC1240
Output Current (Maximum)	80A (AC Charger 40A, DC Charger 40A)
Output Voltage	12V Nominal
Output Power (Maximum)	1000W
Selectable Battery Type	GEL, AGM, Flooded, Lithium, Program
Bulk /Float Voltage/Restart Range	14.4 Vdc / 13.7 Vdc / 12.8 – 13.5 Vdc
GEL:	14.6 Vdc / 13.6 Vdc / 12.8 – 13.4 Vdc
AGM:	14.4 Vdc / 13.3 Vdc / 12.8 – 13.1 Vdc
Flooded:	13.9 - 14.6 Vdc / 13.5 – 14.4 Vdc / 12.8 – 13.8 Vdc
Lithium:	13.9 - 14.6 Vdc / 13.5 – 14.4 Vdc / 12.8 - 13.8 Vdc
Program:	13.9 - 14.6 Vdc / 13.5 – 14.4 Vdc / 12.8 - 13.8 Vdc
Charger Current (User Selectable)	20-80A (20A steps)
Equalized Voltage (Flooded Battery only)	15.5 Vdc
Equalized Charging Current	10% of Bulk Current Setting
Charging Control	GEL, AGM Flooded: selectable Two or Three stages Lithium, Program: Three stages
DC Output Bank	Single
Current draw from CH1 with unit ON	< 300mA
Current draw from CH1 with Unit OFF	< 30 mA
Battery Temperature Setting	Low / Normal / High (automatically overridden by optional BTS)
Efficiency	95%
Minimum Operating Voltage	8.0 Vdc
PV Input Voltage	14.5 – 55 Vdc
Maximum Solar Input Current	40A
Maximum Solar Input Power:	1000W
Alternator Input Voltage	10.5 – 16.0 Vdc / 21 – 32 Vdc
Maximum Input Current (as per max. setting)	50A
Storage Range	-40° to 70° C (-40° to 158° F)
Operating Range	-20° to 60° C (-4° to 140° F)
Humidity	5-95%, RH non-condensing
Ingress Protection	IP32
DMT12100	7.6 lb., 17.9x9.4x4.1 inches (3.45 Kg, 455x238x104 mm)
Standards/EMC (North America)	Class B according to FCC Part15
Standards/EMC (European Union)	CE LVD CE EMC

Accessories:

Display Panel UCRM1201
 Display Panel Connection Cable
 IEC AC Input Cable

Optional Accessory:

Battery Temperature Sensor BTS-10K

7. WARRANTY

Two Year Limited Warranty

The limited warranty program is the only one that applies to this unit, and it sets forth all the responsibilities of **KISAE**. There is no other warranty, other than those described herein. Any implied warranty of merchantability of fitness for a particular purpose on this unit is limited in duration to the duration of this warranty.

This unit is warranted, to the original purchaser only, to be free of defects in materials and workmanship for two years from the date of purchase without additional charge. The warranty does not extend to subsequent purchasers or users.

Manufacturer will not be responsible for any amount of damage in excess of the retail purchase price of the unit under any circumstances. Incidental and consequential damages are specifically excluded from coverage under this warranty.

This warranty does not apply to damage to units from misuse or incorrect installation/connection. Misuse includes wiring or connecting to improper polarity power sources.

RETURN/REPAIR POLICY:

If you are experiencing any problems with your unit, please contact our customer service department at info@kisaetechnology.com or phone 1 877 897-5778 before returning product to retail store. After speaking to a customer service representative, if products are deemed non-working or malfunctioning, the product may be returned to the purchasing store within 30 days of original purchase. Any defective unit that is returned to manufacturer within 30 days of the date of purchase will be replaced free of charge.

If such a unit is returned more than 30 days but less than two years from the purchase date, manufacturer will repair the unit or, at its option, replace it, free of charge. If the unit is repaired, new or reconditioned replacement parts may be used, at manufacturer's option. A unit may be replaced with a new or reconditioned unit of the same or comparable design. The repaired or replaced unit will then be warranted under these terms for the remainder of the warranty period. The customer is responsible for the shipping charges on all returned items.

LIMITATIONS:

This warranty does not cover accessories, such as adapters and batteries, damage or defects result from normal wear and tear (including chips, scratches, abrasions, discoloration or fading due to usage or exposure to sunlight), accidents, damage during shipping to our service facility, alterations, unauthorized use or repair, neglect, misuse, abuse, failure to follow instructions for care and maintenance, fire and flood.

If your problem is not covered by his warranty, contact our Customer Service Department at info@kisaetechnology.com or 1 877 897-5778 for general information if applicable.

Service Contact Information Email:info@kisaetechnology.com

Phone: 1-877-897-5778

www.kisaepower.com

Appendix 1 Unit Setting Mode

Unit button function

- 'Menu/Set' button has different functions with different operation stages.
 - o During normal operation, press and hold **Menu/Set** button for ~ 3 seconds to display unit settings starting with priority setting (PRI P1-P6).
 - o During unit setting operation, press **Menu/Set** button to confirm the selected parameter.
- 'Up' or 'Down' buttons have different functions with different operation stages.
 - o When the display is in the setting stage, use these buttons to toggle between different setting values.
 - o When the display parameter is set, use these buttons to toggle between different choices of set functions. See all the settings below.
- 'Escape' button to quit setting mode and returns to earlier setting or normal operation.

Procedure to enter 'Unit Setting' stage

During normal operation, press and hold **Menu/Set** button for ~3 seconds to enter unit setting stage.

1) Priority Setting on DC to DC Charging for Alternator or Solar Input

Display shows '**PRI - P1-P6**' indicating current priority setting.

Selectable Priority Setting type:

- PRI P1** (Alternator Priority with Ignition Start signal)
- PRI P2** (Solar Priority)
- PRI P3** (Alternator Priority without Ignition Start signal)
- PRI P4** (Solar Only)
- PRI P5** (Alternator with Ignition Start Only)
- PRI P6** (Alternator Only)

Setting 1: Alternator or Solar Input Priority Setting ('PRI' – 'P1 to P6') for use with Alternator or Solar Input

- To change priority setting, press **Menu/Set** button once and display will have existing setting flashing. Use **Up** or **Down** button to modify the Priority Setting. Once the new setting is decided, use **Menu/Set** button to confirm the selection and display will go return to **Setting 1**.
- To skip priority setting, use **Up** button to go to setting 'Mfd' or use **Down** button to go to SECTION 2 (Battery type setting).
- To quit unit setting, use **Escape** button to return to normal operation.

2) Battery Type Setting ('bAT – battery type')

Display shows '**bAT - battery type**' indicating current battery type setting on the unit.

- To make change on battery type, press **Menu/Set** button once and display will go to **Setting 2.1**.
- To make change to the parameters set on the existing battery type, press **Menu/Set** button twice and display will go to **Setting 2.2**.
- To ignore any setting change on battery type or set parameters, use **Down** button to go to SECTION 4 (Alternator Input StartUp Volatge Setting 'CH3') and **Up** button to go back to **Setting 1**.

Setting 2.1: Change Battery type and parameter setting: Battery types available are 'GEL', 'AGM', 'Flooded', 'Lithium' and 'Program'.

- The existing battery type setting will flash. Use **Up** or **Down** button to modify Battery Type Setting. Once the new setting is decided, use **Menu/Set** button to confirm the selection. If 'GEL' or 'AGM' or 'Flooded' battery type is chosen, follow **Setting 2.2** to continue with the remaining settings for the chosen battery. If Lithium 'LI' battery type is chosen, go to Section 3 and follow **Setting 3.0** to continue the Lithium Battery setting. If Program 'PGM' battery type is chosen, go to section 4 and follow **Setting 4.0** to continue the Program Battery setting.
- To skip battery type setting, use **Up** button to return to **Setting 1** or use **Down** button to go to SECTION 5 and continue with other unit settings not related to the battery.

Setting 2.2: Battery Recharge Voltage setting

Display shows '**REC**' and flashing (Voltage selectable range is GEL: 12.8 – 13.5V, AGM: 12.8 – 13.4, Flooded: 12.8 – 13.1V)

- To view or change battery recharge voltage setting, Press **Menu/Set** once to show the set battery recharge voltage setting. Use **Up** and **Down** buttons to change setting and once the setting is chosen, press **Menu/Set** button to confirm the setting and display will go to **Setting 2.3**.
- To ignore the change of the battery recharge voltage setting, use **Down** button to go to **Setting 2.3** or use **Escape** button to return to **Setting 2.1**.

Setting 2.3: Bulk/Maximum Charge Current setting:

Display shows the existing maximum current setting ('H and current in A'). The selectable choices are: '**H20**' (=20A), '**H40**' (=40A), '**H60**' (=60A), '**H80**' (=80A).

- To change bulk/maximum charge current, use **Up** or **Down** button to modify the current setting. Once the setting is chosen, use **Menu/Set** button to confirm and display will go to **Setting 2.4**.
- To cancel the setting, press **Escape** button to return to **Setting 2.1**.

Setting 2.4: Absorption (ABS) to Float Stage Current setting:

Display shows existing Absorption to Float current setting ('L and current in A'). The selectable choices depend on the selected Bulk/Maximum charge current setting chosen in setting 2.3 above. See chart below:

Bulk/Maximum Charge Current selected in 2.3	Selectable ABS to Float Stage Current in A		
H20 (=20A)	2	4	6
H40 (=40A)	4	6	8
H60 (=60A)	4	6	8
H80 (=80A)	4	6	8

- To change ABS to Float Stage Current, use **Up** or **Down** button to modify the current. Once the setting is chosen, use **Menu/Set** button to confirm and display will go to **Setting 2.5**.
- To cancel the setting, press **Escape** button to return to **Setting 2.1**

Setting 2.5: 2-stage or 3-stage setting: ('Mod')

Display shows '**Mod**' and flashing

- To view or change existing setting, use **Menu/Set** button to view setting, use **Up** or **Down** button to modify the setting. Once the setting is chosen, use **Menu/Set** button to confirm and display will go to **Setting 2.6**.
- To ignore the '**Mod**' setting change, use **Up** button to return to **Setting 2.4** or use **Down** button to go to setting 2.6 or press **Escape** button to return to **Setting 2.1**.

Setting 2.6. Battery Temperature Setting: ('bTm');

Display shows '**bTm**'

- To view or change battery temperature setting, use **Menu/Set** button to view setting, use **Up** or **Down** button to modify the setting. Once the setting is chosen, use **Menu/Set** button to confirm the setting. If **Flooded** battery type is chosen in setting 2, the display will go to **Setting 2.7** but if **GEL** or **AGM** is chosen in setting 2, the display will go to SECTION 5.
- To ignore the Battery Temperature Setting change, use **Up** button to return to **Setting 2.5** or press **Escape** button to return to **Setting 2.1**.

Setting 2.7. Activating the Battery Equalization Process for Flooded battery type only:

Display shows '**E9**' and flashing.

- To view or change equalization process, use **Menu/Set** button to view setting, use **Up** or **Down** button to switch the process between **OFF** or **ON**. To confirm the setting, use **Menu/Set** button to confirm the setting. If **YES** is chosen, the equalization process will begin display goes back to Section 2.0 and if **OFF** is chosen, the **Equalization** process will terminate, and display returns to **Setting 2.1**.
- To ignore the setting, use **Up** button to return to **Setting 2.6** or press **Escape** button to return to **Setting 2.1**.

3) If '**Lithium**' battery type is chosen, use the following steps to continue the remain settings for the chosen battery.

Setting 3.0. Choice of Bulk Voltage (CV) setting:

Display shows '**BUL**' and flashing (Voltage range available for selection is 13.9 – 14.6V).

- To view or change Bulk voltage setting, press **Menu/Set** button once and current Bulk voltage setting is displayed. Use **Up** or **Down** button to change voltage and once the voltage is chosen, press **Menu/Set** button once to confirm the setting and display will go to **Setting 3.1**.
- To ignore the change of the Bulk Voltage setting, use **Down** button to go to **Setting 3.1** or use **Escape** button to return to **Setting 2.1**.

Setting 3.1. Choice of Float Voltage setting:

Display shows '**Flo**' and flashing. (Voltage range available for section is 13.5 – 14.4V).

- To view or change Float Voltage setting, press **Menu/Set** button once and current Float voltage setting is displayed. Use **Up** or **Down** button to change voltage. Once the voltage is chosen, press **Menu/Set** button once to confirm the setting and display will go to **Setting 3.2**.
- To ignore the change of the Float Voltage setting, use **Down** button to go to Setting 3.2 or use **Escape** button to return to **Setting 2.1**.

Setting 3.2. Battery Recharge Voltage setting

Display shows '**REC**' and flashing (Voltage selectable range is 12.8 – 13.8V)

- To view or change battery recharge voltage setting, Press **Menu/Set** once to show the current Battery Recharge Voltage setting. Use **Up** and **Down** buttons to change settings and once the setting is chosen, press **Menu/Set** button to confirm the setting and display will go to **Setting 3.3**.
- To ignore the change of the battery recharge voltage setting, use **Down** button to go to **Setting 3.3** or use **Escape** button to return to **Setting 2.1**.

Setting 3.3. Choice of Maximum Charging Current:

Display shows current maximum current setting ('**H** and current in A'). The selectable choices are: '**H20**' (=20A), '**H40**' (=40A), '**H60**' (=60A), '**H80**' (=80A).

- To change bulk/maximum charge current, use **Up** or **Down** button to modify the current setting. Once the setting is chosen, use **Menu/Set** button to confirm and display will go to **Setting 3.4**.
- To cancel the setting, press **Escape** button to return to **Setting 2.1**.

Setting 3.4. Absorption (ABS) to Float Stage Current setting:

Display shows current Absorption to Float current setting ('**L** and current in A'). The selectable choices depend on the selected Bulk/Maximum charge current setting chosen in 3.3. See chart below:

Bulk/Maximum Charge Current selected in 3.3	Selectable ABS to Float Stage Current in A		
H20 (=20A)	2	4	6
H40 (=40A)	4	6	8
H60 (=60A)	4	6	8
H80 (=80A)	4	6	8

- To change ABS to Float Stage Current, use **Up** or **Down** button to modify the current setting. Once the setting is chosen, use **Menu/Set** button to confirm and display will go to **Setting 2.0**.
- To cancel the setting, press **Escape** button to return to **Setting 2.1**.

4) If '**Program**' battery type is chosen, use the following steps to continue the remaining settings for the chosen battery.

Setting 4.0. Choice of Bulk Voltage (CV) setting:

Display shows '**BUL**' and flashing (Voltage range available for selection is 13.9 – 14.6V).

- To view or change Bulk voltage setting, press **Menu/Set** button once and current Bulk voltage setting is displayed. Use **Up** or **Down** button to change voltage and once the voltage is chosen, press **Menu/Set** button once to confirm the setting and display will go to **Setting 4.1**.
- To ignore the change of the Bulk Voltage setting, use **Down** button to go to **Setting 4.1** or use **Escape** button to return to **Setting 2.1**.

Setting 4.1. Choose of Float Voltage setting:

Display shows '**Flo**' and flashing. (Voltage range available for selection is 13.5 – 14.4V).

- To view or change Float Voltage setting, press **Menu/Set** button once and current Float voltage setting is displayed. Use **Up** or **Down** button to change voltage. Once the voltage is chosen, press **Menu/Set** button once to confirm the setting and display will go to **Setting 4.2**.
- To ignore the change of the Float Voltage setting, use **Down** button to go to **Setting 4.2** or use **Escape** button to return to

Setting 2.1.

Setting 4.2: Battery Recharge Voltage setting

Display shows 'REC' and flashing (Voltage selectable range is 12.8 – 13.8V)

- To view or change battery recharge voltage setting, pressing **Menu/Set** once will show the current Battery Recharge Voltage setting. Use **Up** and **Down** buttons to change setting and once the setting is chosen, press **Menu/Set** button to confirm the setting and display will go to Setting 4.3.
- To ignore the change of the battery recharge voltage setting, use **Down** button to go to Setting 4.3 or use **Escape** button to return to Setting 2.1.

Setting 4.3. Choice of Maximum Charging Current:

Display shows current maximum current setting ('H and current in A'). The selectable choices are: 'H20' (=20A), 'H40' (=40A), 'H60' (=60A), 'H80' (=80A).

- To change bulk/maximum charge current, use **Up** or **Down** button to modify the current setting. Once the setting is chosen, use **Menu/Set** button to confirm and display will go to Setting 4.4.
- To cancel the setting, press **Escape** button to return to Setting 2.1.

Setting 4.4. Absorption (ABS) to Float Stage Current setting:

Display shows current Absorption to Float current setting ('L and current in A'). The selectable choice depends on the selected Bulk/Maximum charge current setting chosen in 4.3. See chart below:

Bulk/Maximum Charge Current selected in 4.3	Selectable ABS to Float Stage Current in A		
H20 (=20A)	2	4	6
H40 (=40A)	4	6	8
H60 (=60A)	4	6	8
H80 (=80A)	4	6	8

- To change ABS to Float Stage Current, use **Up** or **Down** button to modify the current setting. Once the setting is chosen, use **Menu/Set** button to confirm and display will go to Setting 4.5.
- To cancel the setting, press **Escape** button to return to Setting 2.1.

Setting 4.5: 2-stage or 3-stage setting: ('Mod')

Display shows 'Mod' and flashing

- To view or change existing setting, use **Menu/Set** button to view setting, use **Up** or **Down** button to modify the setting. Once the setting is chosen, use **Menu/Set** button to confirm and display will go to Setting 4.6.
- To ignore the 'Mod' setting change, use **Up** button to go back to Setting 4.4 or use **Down** button to go to Setting 4.6 or press **Escape** button to return to Setting 2.1.

5) Alternator CH3 Input Startup Voltage Setting ('CH3')

Display shows 'CH3 - Input Voltage'. (Voltage range available for setting is 12.5 – 13.8V, 25 – 27.6V)

- To change CH3 input Startup voltage, press **Menu/Set** once and use **Up** and **Down** buttons to change voltage setting. Once the setting is chosen, press **Menu/Set** button to confirm the setting and the display will go to Section 5.

Note: If CH3 Input Startup voltage is set to within 12.5 – 13.8V range, the unit will assume a 12V Alternator system is in use and if the CH3 Input Startup voltage is set to within 25 – 27.6V range, the unit will assume the 24V Alternator system is in use. Selecting the wrong Alternator system will lead to overcharging the alternator battery or unit will not operate properly.

- To ignore the CH3 setting and go to the other settings, use **Down** button to go to the next setting in SECTION 6, or use **Up** button to go to the earlier setting in SECTION 2.
- To terminate the whole unit setting process, press the **Escape** button. The display will revert to normal operation.

6) Trickle Charge Alternator Battery Function ('STC')

Display shows 'STC – Status' (function available is OFF or ON).

- To change **STC** setting, press **Menu/Set** once and use **Up** and **Down** buttons to change setting between OFF - Function Off and On – Function On. Once the setting is chosen, press **Menu/Set** button to confirm the setting and the Trickle charge function will proceed. (Note: This function will only work with P4 (Solar only) setting only.)
- To ignore the **STC** setting and go to the other settings, use **Down** button to go to SECTION 7, or use **Up** button to go to the earlier setting in SECTION 2.
- To terminate the whole unit setting process, press the **Escape** button. The display will revert to normal operation.

7) Lithium Battery Restart ('SIL')

Display shows 'SIL – Status' (function available is OFF or ON)

- To change Lithium Battery Restart function, press **Menu/Set** once and use **Up** and **Down** buttons to change settings between OFF (Function Off) and ON (Function On). Once the function is chosen press **Menu/Set** button to process. Display will go to SECTION 8.
- To ignore the change on the Lithium Battery Restart function, use **Up** button to go to SECTION 6 or **Down** button to go to SECTION 7.
- To terminate the whole unit setting process, press the **Escape** button. The display will revert to normal operation

8) Manufacturing Default Setting ('Mfd')

Display shows 'Mfd-no'

- To reset all settings to manufacturing default settings, press **Menu/Set** button once and use **Up** or **Down** button to change the display to 'YES' and press **Menu/Set** button again to confirm. Display will show 'Mfd-no' again and all the settings on the unit will go back to the manufacturing default settings.

KISAESM