

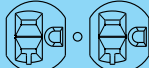





Features:

- Pure sine wave output
- Power ON / OFF remote control (Green Terminal)
- Remote controller CR-8 / CR-16A (optional)
- Input & Output fully isolation
- Temperature & Load controlled cooling fan
- Built in advance microprocessor to provide friendly interface
- Output frequency 50 / 60 Hz selectable by DIP switch
- Output voltage DIP switch selectable
- Adjustable power saving mode by variable resister
- 3-color LED status indicators
- Input protection: Reverse Polarity (Fuse) / Under Voltage / Over Voltage
- Output protection: Short Circuit / Overload / Over Temperature
- E13 / UL / CE / FCC approved



MODEL		SP-2000-112	SP-2000-124	SP-2000-148	SP-2000-212	SP-2000-224	SP-2000-248	
Output	AC Voltage	100 / 110 / 115 / 120VAC			200 / 220 / 230 / 240VAC			
	AC Regulation	±5%			±3%			
	Rated Power	2000VA						
	Surge Power (Max.3 Sec)	<3500VA						
	Maximum Output Power (1 Min)	>2000VA~2300VA (100%~115%)						
	Output Waveform	Pure Sine Wave (THD<5%@Normal Load NOTE1)			Pure Sine Wave (THD<3%@Normal Load NOTE2)			
	Frequency	50 / 60 Hz ±0.5%						
Input	DC Voltage	12VDC	24VDC	48VDC	12VDC	24VDC	48VDC	
	Voltage Range	10.5 ~ 16.5VDC	21.0 ~ 33.0VDC	42.0 ~ 66.0VDC	10.5 ~ 16.5VDC	21.0 ~ 33.0VDC	42.0 ~ 66.0VDC	
	NO Load Current	≤1.8A@12VDC	≤1.0A@24VDC	≤0.5A@48VDC	≤1.8A@12VDC	≤1.0A@24VDC	≤0.5A@48VDC	
	Power Saving Mode	<0.1A@12VDC	<0.05A@24VDC	<0.05A@48VDC	<0.1A@12VDC	<0.05A@24VDC	<0.05A@48VDC	
	Efficiency (Max.)	92%	93%	94%	94%	94%	95%	
Protection	Input Under - Voltage Protection	10.5 ±0.3VDC	21.0 ±0.5VDC	42.0 ±1.0VDC	10.5 ±0.3VDC	21.0 ±0.5VDC	42.0 ±1.0VDC	
	Input Under - Voltage Recovery	12.5 ±0.3VDC	25.0 ±0.5VDC	50.0 ±1.0VDC	12.5 ±0.3VDC	25.0 ±0.5VDC	50.0 ±1.0VDC	
	Input Over - Voltage Protection	16.5 ±0.3VDC	33.0 ±0.5VDC	66.0 ±1.0VDC	16.5 ±0.3VDC	33.0 ±0.5VDC	66.0 ±1.0VDC	
	Input Over - Voltage Recovery	14.5 ±0.3VDC	29.0 ±0.5VDC	58.0 ±1.0VDC	14.5 ±0.3VDC	29.0 ±0.5VDC	58.0 ±1.0VDC	
	Output Overload	Shutdown output voltage, restart to recover						
	Output Short	Shutdown output voltage, restart to recover						
	Over Temperature	Heat sink temperature over 80°C ±5°C, shutdown output voltage, recover automatically after heat sink temperature goes down to 60°C ±5°C						
Environment	DC Input Reverse Polarity	By fuse						
	Operating Temp.	-20°C ~ +40°C ; 60°C @40% power load						
	Storage Temp.	-30°C ~ +70°C						
Safety & EMC	Storage Temp. & Humidity	10 ~ 95% RH						
	Safety Standards	Certified UL 458 NOTE3			----	Certified EN 60950-1		
	EMC Standards	Certified FCC class A NOTE4			Certified EN 55022 class A NOTE4 ; EN 55024 EN 61000-3-2, -3-3 EN 61000-4-2, 3, 4, 5, 6, 8, 11			
Control & Signal	E-mark	----			Certified CISPR 25 ISO 7637-2			
	Accessory (Optional)	Remote Control: CR-8 / CR-16A; Transfer Switch: TR-40						
	LED Indicator	Input voltage level, output load level and faulty status						
	Dry Contact Terminal	By relay						
Others	Remote Control Terminal	6-port green terminal						
	Dimension (W x H x D)	248x83x443 mm / 9.76x3.27x17.44 inch						
	Packing	5.24kg; 4pcs / 21.96kg / 3.58CUFT						
	Cooling	Temperature & load controlled cooling fan						
	Application	Home and office appliances, portable power equipment, vehicle, yacht and off-grid Solar power systems ...etc.						
Socket Type		 North America (GFCI)		 North America (NEMA 5-20R)		 Continental European (SCHUKO)		
				 Australia / New Zealand		 United Kingdom		
					 Universal		 France Connector	

Note1 - Normal Condition: Vin=12.5V / 25V / 50V Vo=100 / 110 / 115 / 120 VAC 80% Full load (PF=1.0)

Note2 - Normal Condition: Vin=12.5V / 25V / 50V Vo=200 / 220 / 230 / 240 VAC 80% Full load (PF=1.0)

Note3 - UL only for GFCI receptacles

Note4 - Warning: This is a class A product. In a domestic environment this product may cause radio interference in which case the user may be required to take adequate measures.

Mechanical Drawings:

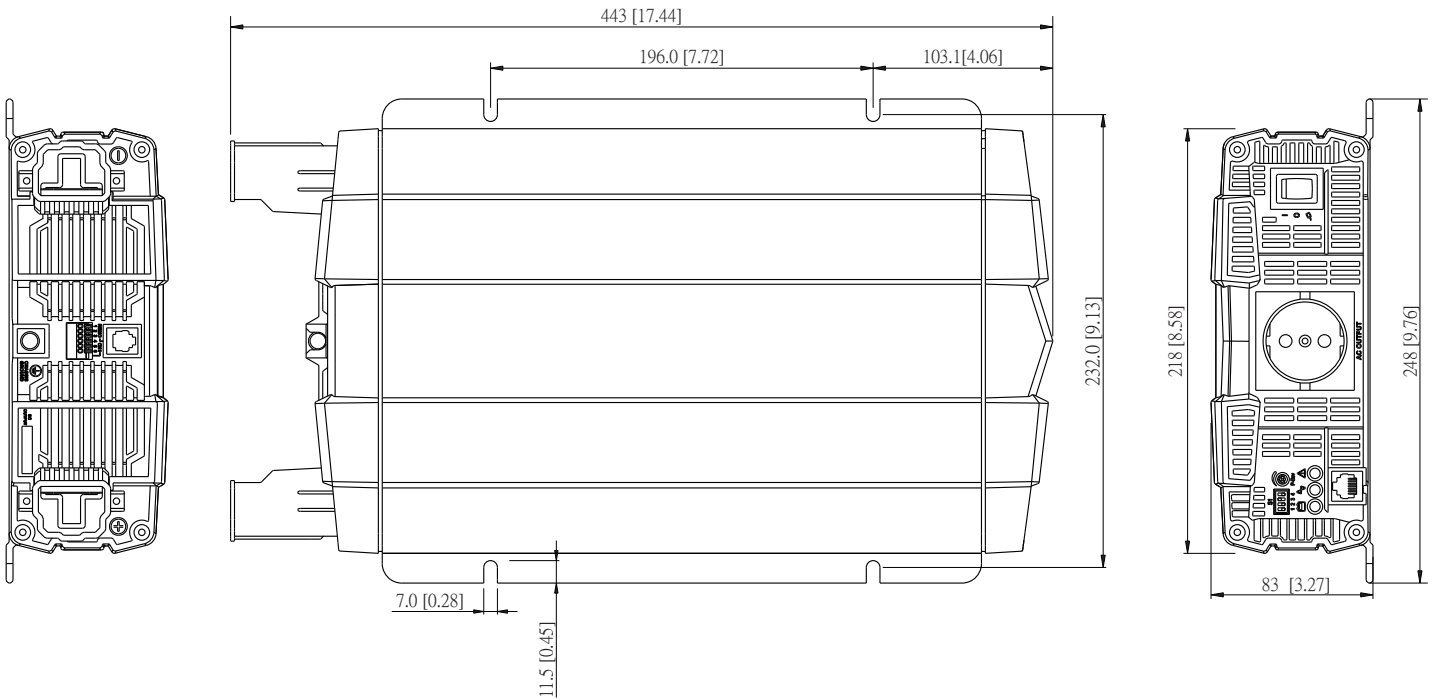

Power Voltage Curve:

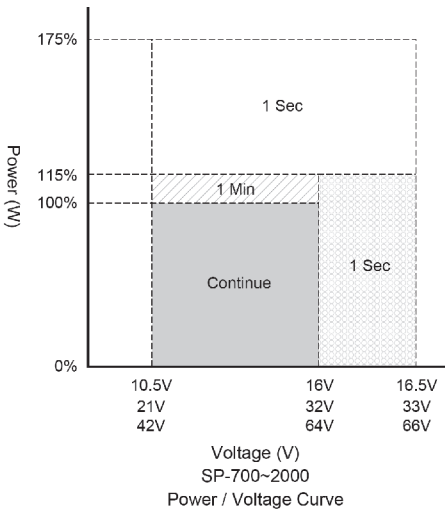

Power Temperature Curve:

