



# ME-MR

## Mini Remote Control



## Owner's Manual

(Revision 1.3 or higher)



**Sensata**  
Technologies

Thank you from all of us at Sensata Technologies for purchasing this ME-MR remote. The ME-MR is a product under the Magnum Energy brand from Sensata. We understand there are many purchasing options in the marketplace, and are pleased that you have decided on a Magnum product. We are committed to providing quality products and services. We hope your experience with us is pleasant and professional.

### **Disclaimer of Liability**

The use of this manual and the conditions or methods of installation, operation, use, and maintenance of the ME-MR is beyond the control of Sensata Technologies. Therefore, this company does not assume responsibility and expressly disclaims liability for loss, damage, or expense whether direct, indirect, consequential or incidental that may arise out of or be in any way connected with such installation, operation, use, or maintenance.

Due to continuous improvements and product updates, the images shown in this manual may not exactly match the unit purchased.

### **Restrictions on Use**

The ME-MR remote may only be used in life support devices and systems with the express written approval of Sensata Technologies. Failure of this inverter can reasonably be expected to cause failure of that life support device or system, or to affect the safety or effectiveness of that device or system. If the ME-MR remote fails, it is reasonable to assume the health of the user or other persons may be endangered.

### **Copyright Notice**

Copyright 2020 by Sensata Technologies. All rights reserved. Permission to copy, distribute, and/or modify this document is prohibited without written permission from Sensata.

### **Document Information**

Description – ME-MR Owner’s Manual

Part Number and Revision – 64-0031 Rev F

Date Published – April 2020

This entire manual is available for download—with many of the diagrams available in color—under the Document Library section—on our website.

### **Contact Information**

Sensata Technologies (for Magnum Energy Products):

Customer Service: [InverterInfo@Sensata.com](mailto:InverterInfo@Sensata.com)

Tech Support: [MagnumSupport@Sensata.com](mailto:MagnumSupport@Sensata.com)

Web: [www.SensataPower.com](http://www.SensataPower.com)

## Important Product Safety Instructions

This manual contains safety instructions that must be followed during the installation and operation of this product. Read all instructions and safety information contained in this manual before installing or using this product.

### Safety Symbols

To reduce the risk of electrical shock, fire, or other safety hazard, the following safety symbols have been placed throughout this manual to indicate dangerous and important safety instructions.



**WARNING:** Indicates that failure to take a specified action could result in physical harm to the user.



**CAUTION:** Indicates that failure to take a specified action could result in damage to the equipment.



**Info:** Indicates information that emphasizes or supplements important points of the main text.



**Remedy:** Provides possible solutions for related issues.

### Product Safety Alerts

All electrical work must be performed in accordance with local, state, and federal electrical codes.



#### **WARNINGS:**

- This product is designed for indoor/compartment installation. It must not be exposed to rain, snow, moisture, or liquids of any type.
- Use insulated tools to reduce the chance of electrical shock or accidental short circuits.
- Remove all jewelry such as rings, watches, bracelets, etc., when installing or performing maintenance on the inverter.
- Always disconnect the batteries or energy source prior to installing or performing maintenance on the inverter. Live power may be present at more than one point since an inverter utilizes both batteries and AC - turning off the inverter may not reduce this risk. As long as AC power is connected, it will pass thru the inverter regardless of the power switch on the inverter or the ON/OFF button on the remote.

# Table of Contents

<b>1.0</b>	<b>Introduction</b>	<b>1</b>
<b>2.0</b>	<b>Installation</b>	<b>2</b>
2.1	Pre-Installation	2
2.1.1	Installation Guidelines	2
2.1.2	Unpacking and Inspection	2
2.1.3	Tools Required	2
2.2	Installation Procedure	3
2.2.1	Flush Mounting the Remote	3
2.2.2	Surface Mounting the Remote using the Bezel	3
2.2.3	Connecting the Remote Cable	4
2.2.4	Connecting the ME-MR to a Magnum Inverter	4
<b>3.0</b>	<b>Setup</b>	<b>5</b>
3.1	Navigating the Remote	5
3.2	Remote Feature to Inverter Compatibility	6
3.3	Remote Menu Items	7
3.3.1	AC IN Menu	7
3.3.2	Search Watts Menu	8
3.3.3	Battery Amp-Hours Menu	9
3.3.4	Battery Type Menu	11
3.3.5	Charge Rate Menu	13
3.3.6	Low Battery Cut-Out (LBCO) Menu	14
3.3.7	VAC Dropout Menu	15
3.3.8	Power Save Menu	16
3.3.9	Equalize Menu	17
3.3.10	Charger Standby Menu	18
3.3.11	Power On Menu	18
3.3.12	TECH Menu	19
<b>4.0</b>	<b>Menu Map: ME-MR Remote Control</b>	<b>21</b>
<b>5.0</b>	<b>Operation</b>	<b>22</b>
5.1	Front Panel	22
5.1.1	LED Indicators	22
5.1.2	LCD Display	22
5.1.3	ME-MR Remote Buttons	22
5.2	Operating the Inverter/Charger	23
5.3	System Status Messages	24
5.3.1	Inverter Mode Messages	24
5.3.2	Charger Mode Messages	25
5.3.3	Fault Mode Messages	30
5.3.3.1	System Fault Messages	30
5.3.3.3	Internal Fault Messages	38
5.3.4	LED Indicator Guide	39
<b>6.0</b>	<b>Troubleshooting</b>	<b>40</b>
6.1	Troubleshooting Tips	41
6.1.1	Inverter Problems:	41
6.1.2	Charger Problems:	41
6.2	Performing an Inverter Reset	42
6.3	Performing a Power Reset	42
<b>7.0</b>	<b>Warranty Information</b>	<b>43</b>
7.1	Warranty Statement	43
7.2	Warranty Service	43

## List of Figures

Figure 1-1, Front Panel Features .....	1
Figure 2-1, Cut-Out Dimensions for Flush Mounted Remote .....	3
Figure 2-2, Bezel Dimensions for Surface Mounted Remote .....	3
Figure 2-3, Remote Cable .....	4
Figure 2-4, Remote Control Connections .....	4
Figure 3-1, Scrolling Home Screens .....	5
Figure 3-2, AC IN Selections .....	7
Figure 3-3, Search Watts Selections .....	8
Figure 3-4, Battery Amp-Hours Selections.....	9
Figure 3-5, Battery Type Selections.....	11
Figure 3-6, Charge Rate Selections .....	13
Figure 3-7, LBCO: Low Battery Cut-Out Selections .....	14
Figure 3-8, VAC Dropout Selections.....	15
Figure 3-9, Power Saver Selections .....	16
Figure 3-10, Equalize Selections .....	17
Figure 3-11, Charger Standby Selections .....	18
Figure 3-12, Power On Selections .....	19
Figure 3-13, TECH Menus .....	20
Figure 4-1, ME-MR Remote Menu Map .....	21
Figure 5-1, ME-MR Front Panel Controls and Indicators .....	22
Figure 5-2, Inverter Standby.....	24
Figure 5-3, Inverting.....	24
Figure 5-4, Off .....	25
Figure 5-5, Searching.....	25
Figure 5-6, Absorb Charging .....	25
Figure 5-7, Bulk Charging .....	26
Figure 5-8, Charger Standby.....	26
Figure 5-9, Charging .....	26
Figure 5-10, Equalizing.....	27
Figure 5-11, Float Charging .....	27
Figure 5-12, Full Charge.....	28
Figure 5-13, Load Support AAC .....	28
Figure 5-14, Load Support VDC .....	29
Figure 5-15, Unknown Mode .....	29
Figure 5-16, AC Overload Fault.....	30
Figure 5-17, BackFeed Fault.....	30
Figure 5-18, Breaker Tripped Fault.....	31
Figure 5-19, Dead Battery Charge Fault.....	31
Figure 5-20, FET Overload Fault.....	32
Figure 5-21, High Battery Fault .....	32
Figure 5-22, High Battery Temp Fault .....	33
Figure 5-23, High Volts AC Fault .....	33

## List of Figures (continued)

Figure 5-24, Low Battery Fault .....	34
Figure 5-25, No Communication .....	34
Figure 5-26, Overcurrent Fault .....	35
Figure 5-27, Overtemp Fault .....	35
Figure 5-28, Stuck Relay Fault.....	36
Figure 5-29, Tfmr Overtemp Fault.....	36
Figure 5-30, Unknown Fault .....	36
Figure 5-31, Stack Clock Fault.....	37
Figure 5-32, Stack Mode Fault.....	37
Figure 5-33, Stack Phase Fault .....	37
Figure 5-34, Internal Bridge Fault .....	38
Figure 5-35, Internal Charger Fault .....	38
Figure 5-36, Internal NTC Sensor Fault.....	38
Figure 5-37, Internal Relay Fault .....	39
Figure 6-1, Performing an Inverter Reset .....	42

## List of Tables

Table 3-1, ME-MR (Revision 1.3) Compatibility Matrix .....	6
Table 3-2, Battery Amp-Hrs to Absorb Charging Time .....	9
Table 3-3, Battery Size to Battery Amp-Hours (estimated) .....	10
Table 3-4, Battery Type to Charge Voltages .....	12
Table 3-5, ME-MR's Inverter/Charger Default Settings.....	20
Table 5-1, LED Indicator Guide .....	39
Table 6-1, Remote Troubleshooting .....	40

## 1.0 Introduction

### 1.0 Introduction

The ME-MR remote control allows you to monitor and customize the basic operating parameters of your Magnum inverter/charger. This remote can be used on all Magnum inverter/charger models.



**Info:** The ME-MR remote control has minimal settings available from its menu. Careful consideration should be given to choosing this remote over the full featured ME-RC when customizing the inverter/charger for your particular system.

The ME-MR25 comes standard with a 25-foot, 4-conductor telephone cable and includes non-volatile memory (preserves adjustable settings, even if power to the remote or inverter is removed).



**Info:** This manual is for the ME-MR remote with Revision 1.3 or higher. See Section 3.3.12 (TECH Menu) for information on how to determine your revision level.

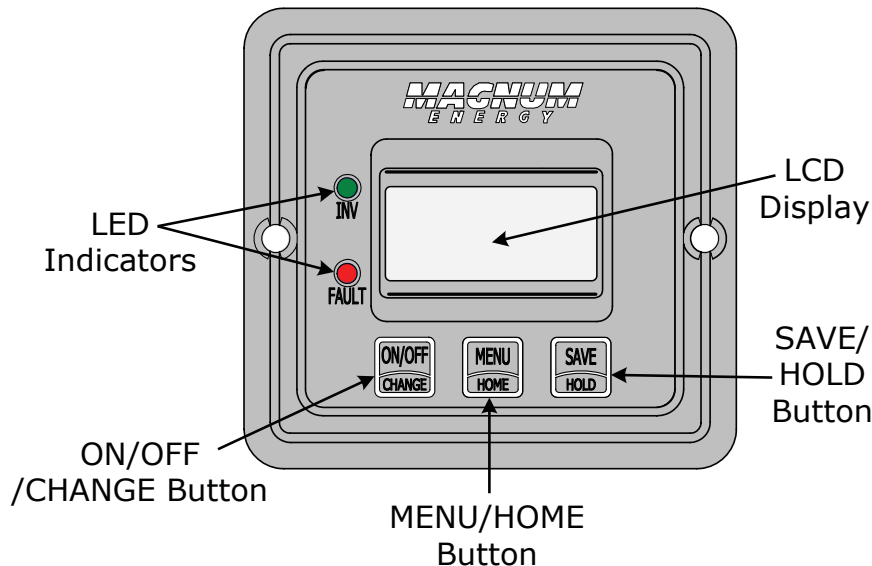

*Figure 1-1, Front Panel Features*

The ME-MR is equipped with the following features:

- **LED Indicators** – The at-a-glance LEDs provide a quick indication of the inverter’s status, or notifies you if a fault is present.
- **LCD Display** – The LCD display is a 8 x 2 line (16 characters total), alphanumeric display used for setting up the inverter/charger operation, as well as viewing current status or fault messages.
- **ON/OFF or CHANGE Button** – This button enables you to turn the inverter on and off, and also serves as a “change” button to navigate through the available settings for each menu.
- **MENU or HOME Button** – This button accesses the remote’s menus. You can also return directly to the scrolling Home screens by pressing and holding this button for 2 seconds.
- **SAVE or HOLD Button** – This button serves as a “save” button to retain your settings. This button also is used as a “hold” button to stop the Home screens from scrolling (press and hold the button for 2 seconds).

## 2.0 Installation

Review this section and the Important Product Safety Instructions on page ii before proceeding with the installation of your remote.



**WARNING:** Installations should be performed by qualified personnel, such as a licensed or certified electrician. The installer determines which safety codes apply and ensures all applicable installation requirements are followed. Applicable installation codes vary depending on the specific location and application.



**CAUTION:** When connecting battery power to the inverter, all battery negative connections must be connected prior to the battery positive connections. When removing battery power from the inverter, the battery positive should be removed before any battery negative connections are disconnected. This prevents any communication chips/lines from becoming the DC return path to the battery—causing permanent damage to all connected accessories.

**Summation:** Ensure all battery negative circuits are always connected before connecting or disconnecting battery positive.

### 2.1 Pre-Installation

Before proceeding, read the entire Installation section to determine how best to install your ME-MR remote. The more thorough you plan in the beginning, the better your inverter needs will be met.

#### 2.1.1 Installation Guidelines

- Before connecting any wires, determine the remote's cable route throughout the home or vehicle/boat, both to and from the inverter.
- Always check for existing electrical, plumbing, or other areas of potential damage BEFORE drilling or cutting into walls to mount the remote.
- Make sure all wires have a smooth bend radius and do not become kinked.
- If installing this remote in a boat, RV, or truck ensure the conductors passing through walls, bulkheads, or other structural members are protected. This minimizes insulation damage (such as chafing) which can be caused by vibration or constant rubbing.

#### 2.1.2 Unpacking and Inspection

Carefully remove the ME-MR remote from its shipping container and inspect all contents. Verify the following items are included:

- The ME-MR remote
- 25' remote cable
- #6 x 1/2" Phillips screws (x2)
- #8 x 3/4" Phillips screws (x4)
- ME-MR Owner's Manual

If items appear to be missing or damaged, contact your authorized Magnum Energy product dealer or Sensata Technologies. Save your proof-of-purchase as a record of your ownership; it is needed if the unit should require in-warranty service.

#### 2.1.3 Tools Required

Installing the remote control is simple and requires the following tools:

- Phillips screwdriver
- Level
- Drill
- Cut-out tool (knife/saw)
- Pencil
- Drill Bit (7/64")



## 2.0 Installation

### 2.2 Installation Procedure

Select an appropriate location to install the ME-MR remote control. Allow ample room to access the remote's buttons and to view the LEDs. Ensure the viewing angle of the display is appropriate. You can either flush mount (concealing the connection) or surface mount the remote.

#### 2.2.1 Flush Mounting the Remote

After selecting the desired location for flush mounting the remote, cut out a square mounting hole measuring  $2\frac{3}{8}$ " x  $2\frac{3}{8}$ " (see Figure 2-1). Place the remote into the cutout, and then use the remote to mark and pre-drill two  $\frac{1}{8}$ " holes for the two supplied #6 x  $\frac{1}{2}$ " Phillips flat head mounting screws.

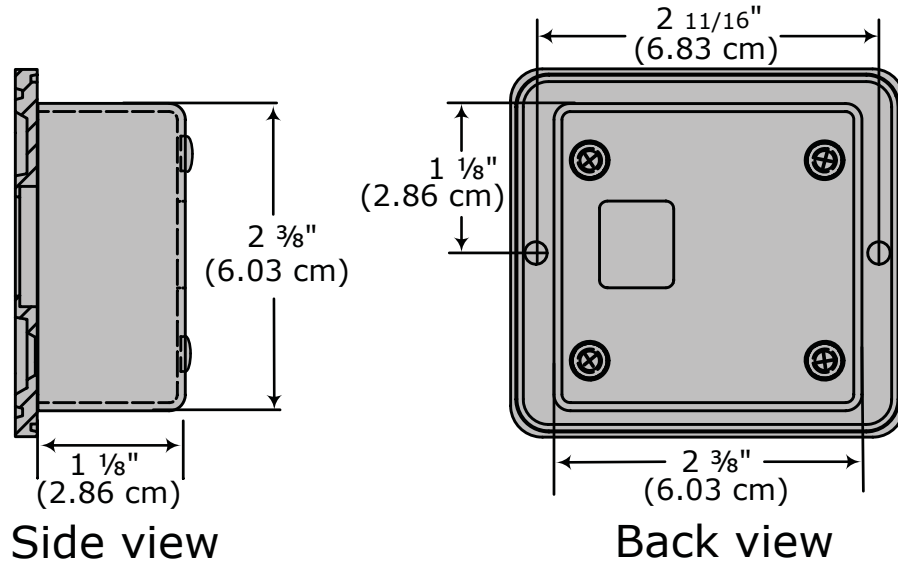

Figure 2-1, Cut-Out Dimensions for Flush Mounted Remote

#### 2.2.2 Surface Mounting the Remote using the Bezel

After selecting the location for surface mounting the remote, use the supplied bezel as a template to mark the mounting holes. Mark and pre-drill four  $\frac{1}{8}$ " holes (see Figure 2-2). Mount the bezel using the four #8 x  $\frac{3}{4}$ " screws.

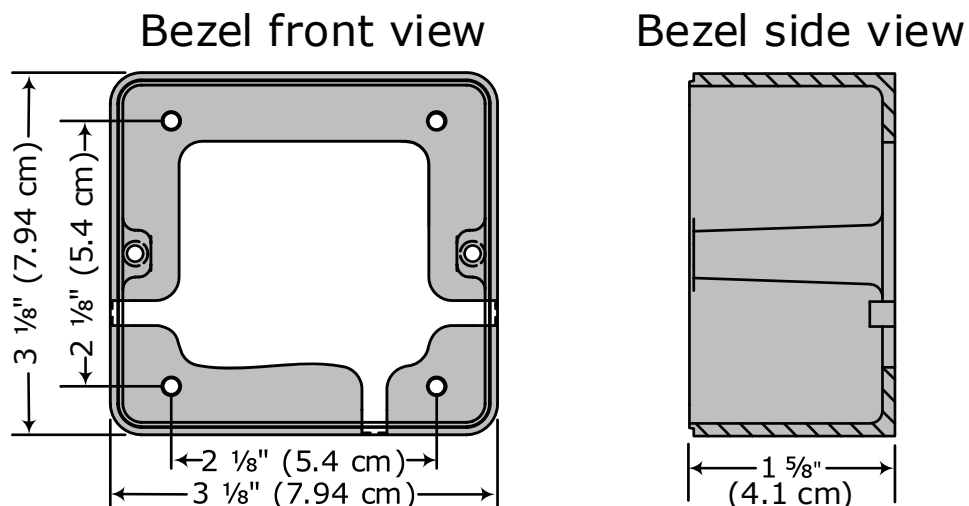

Figure 2-2, Bezel Dimensions for Surface Mounted Remote

### 2.2.3 Connecting the Remote Cable

The ME-MR comes with a remote cable to enable communication between the inverter and the remote. The remote cable is a 25-foot, 4-conductor, flat cable, telephony standard with 6P4C (6-position/4-conductor) connectors on each end. When the 6P4C connectors are held side by side with both of the connector tabs facing the same way, the color of the conductors in each connector is the opposite from top to bottom (see Figure 2-3).



**Info:** The remote cable can be extended up to a length of 200 feet without data degradation.

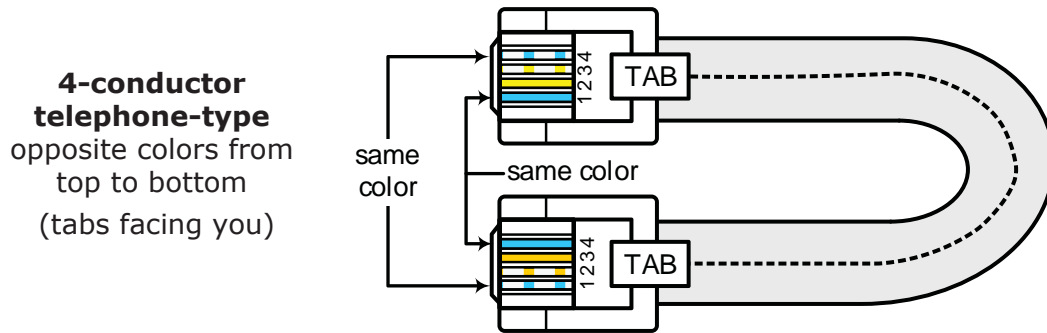

Figure 2-3, Remote Cable

### 2.2.4 Connecting the ME-MR to a Magnum Inverter

One end of the remote cable plugs into the back side of the ME-MR, and the other plugs into the REMOTE (blue) port on the Magnum inverter/charger (see Figure 2-4).

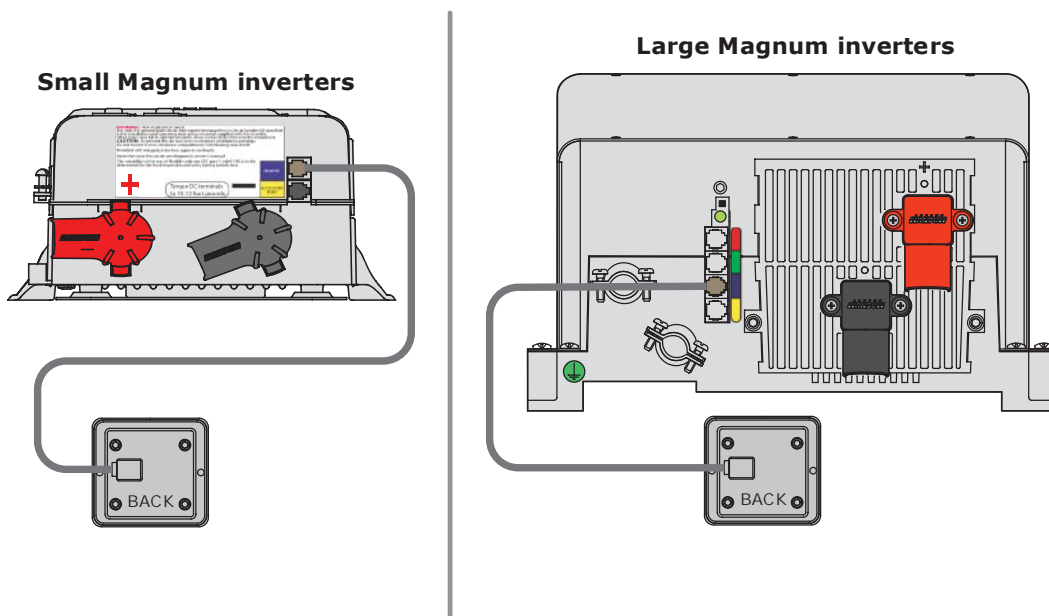

Figure 2-4, Remote Control Connections

## 3.0 Setup

### 3.0 Setup

When the ME-MR remote is connected to a Magnum inverter/charger, the remote's settings determine the inverter/charger's operating parameters. The default settings in the remote (see Table 3-5) are adequate for most installations. However, you can change some of the operating parameters if needed. This section shows you how to navigate the remote, and gives you an understanding of the function of each adjustable setting.

#### 3.1 Navigating the Remote

The ME-MR has menu items and adjustable settings that provide the ability to configure your inverter/charger to your specific parameters.



**Info:** See Figure 4-1 for a complete map of the remote's menu items and adjustable settings.

The items on the remote's front panel are used to find, adjust, and save the desired setting. They are:

- **LCD Display** – The LCD display shows menu items, adjustable settings, and the meter's display information.



**Info:** The LCD display returns to the scrolling Home screens to show inverter status, DC voltage and current, and any fault present (if applicable) after 30 seconds—if no buttons have been pressed.



**Info:** When the "←" (left facing arrow) symbol is shown on the display, it indicates that the displayed setting has been selected and will be used.

- **ON/OFF/CHANGE Button** – Allows you to quickly scroll through and select various menu items and settings after pressing the MENU button.
- **MENU/HOME Button** – Allows easy access to the menu items that can help with configuring, monitoring, and troubleshooting your inverter/charger. Press and hold this button (2 seconds) to return to the scrolling Home screens (see Figure 3-1).
- **SAVE/HOLD Button** – Saves the menu item displayed on the screen. A saved setting is denoted by the arrow symbol. Press and hold this button (2 seconds) to stop the Home screens from automatically scrolling ("HOLD" displays). Once the auto-scrolling has been stopped, you can press the home screen to view the next Home screen. Press and hold again (2 seconds) to resume auto-scrolling of the Home screens ("SCROLL" displays).

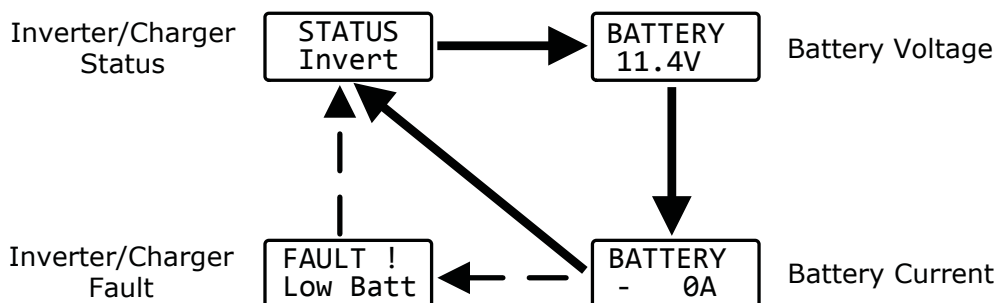

**Note:** Fault screen only appears if a fault has been detected

**Figure 3-1, Scrolling Home Screens**

### 3.2 Remote Feature to Inverter Compatibility

The settings in the ME-MR are designed to work with the standard features in your Magnum inverter. The ME-MR communicates with your inverter to allow the set up and enabling of these standard features. However, when the ME-MR is released with new software, some of the features and functionality in the remote may not be available in an inverter or networked accessory that has an earlier software level. In this case, the setting is not recognized and will not function. Use Table 3-1 below to help you determine which ME-MR (Revision 1.3) menus/features are compatible with your inverter.

1. Obtain your inverter’s software revision.  
*Note: To view the inverter’s software revision level, go to the TECH menu on your remote and access the Revisions menu.*
2. Go to the Magnum Remote Compatibility page at [www.SensataPower.com](http://www.SensataPower.com) to determine your inverter’s compatibility level (L1, L2, L3, L4, or L5).
3. Use Table 3-1 to determine which ME-MR features/settings you want to use, and what inverter compatibility level is required (see the “Inverter Level Required” column in Table 3-1).
4. If your inverter compatibility level is the same or greater than the level required, your inverter can support the setting/feature you want.

**Table 3-1, ME-MR (Revision 1.3) Compatibility Matrix**

FEATURES/SETTINGS		Inverter Level Required	Default Setting
MENU Item	Selections/ Adjustments Range		
AC IN	5 amps, 15 amps, 30 amps, 50 amps	≥Level 1 [1]	30 Amps**
SEARCH	Off, 5 Watt, 20 Watt	≥Level 1	5 Watt
BAT AHRS	200 AH, 400 AH, 600 AH, 800 AH	≥Level 1	400 AH
BAT TYPE	GEL, Flooded, AGM 1, AGM 2	≥Level 1	Flooded
	LFP	≥Level 5	
CHG RATE	10%, 50%, 100%	≥Level 1	100%
LBCO	9.0VDC, 10.0VDC, 11.0VDC*	≥Level 1	10.0VDC
	13.0VDC*	≥Level 5	
VAC DROP	60 VAC, 80 VAC, 100 VAC	≥Level 1	80 VAC
PWR SAVE	Off, On	≥Level 1	On
POWER ON	Norm, Always	≥Level 1	Norm

\* 12-volt values shown; they are different for 24v and 48v inverters.

\*\* These settings return to factory default when power to remote is removed.

ME-MR Compatibility Matrix Notes:

[1] Not available on MM/MM-E/MM-AE/MMS/MMS-E/MMSA/MMA models.

## 3.0 Setup

### 3.3 Remote Menu Items

This section covers the function of each menu item and explains what configurable settings are available from each menu.

#### 3.3.1 AC IN Menu

Use this menu as a quick means of changing your *AC IN* setting to coordinate with the circuit breaker rating from the incoming AC source.

- **AC IN** – This selection ensures the inverter’s AC loads receive the maximum current available from the utility or your generator power. Whenever the utility or generator is connected to the inverter, the current used to power the AC loads and to charge the batteries is monitored. When the total current used to power the AC loads and charge the batteries begins to approach the *AC IN* setting, the current that was used for charging the batteries will automatically be reduced. This ensures the AC loads have all the available current when needed. The feature is not available on MM and MMS Series inverter/chargers.

**Default setting:** *AC IN* = 30 Amps

**Range:** 5 Amps, 15 Amps, 30 Amps, 50 Amps

**Where to set:** Adjust the *AC IN* setting to match the current rating of the utility power or the generator’s circuit breaker. If using multiple AC sources (utility and generator) through an AC transfer switch, adjust this setting to the smaller AC breaker size. This setting is dependent on the stability of the AC source. If using a generator, factors such as altitude and output voltage regulation may require a lower setting than the generator’s breaker size. If the breaker on the AC source is tripping (because it is a weak breaker), try reducing this setting to the next lower level.

**Note:** If the ME-MR is connected to a dual source inverter (i.e., MSH4024RE), the *AC IN* setting applies to both inputs (AC1 and AC2).



**CAUTION:** The *AC IN* setting does not limit the current to the inverter loads. If the current to the loads on the output of the inverter are greater than the circuit breaker rating on the incoming AC source, you may experience nuisance tripping of this breaker.

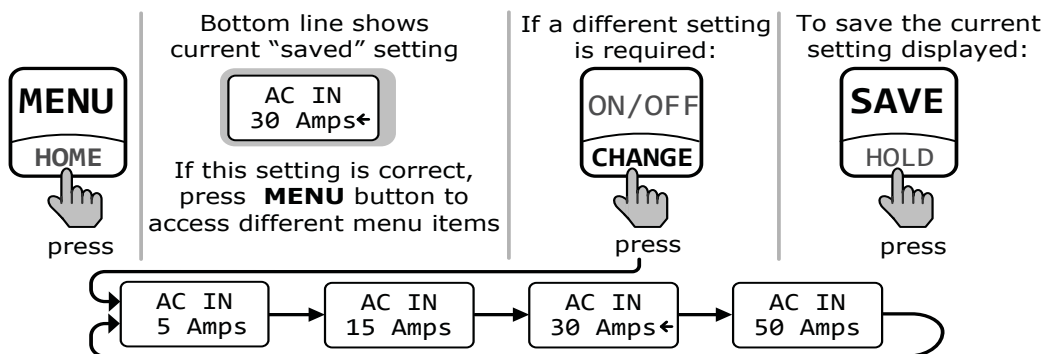

*Figure 3-2, AC IN Selections*

**3.3.2 Search Watts Menu**

- **SEARCH** – This selection allows you to turn off the Search Watts feature, or to adjust the power level to determine when the feature becomes active. If this feature is not needed, select *SEARCH = Off*. When the Search Watts feature is turned off, the inverter continuously provides full AC voltage to the loads.

**Default setting:** *SEARCH = 5 Watts*

**Range:** *Off, 5 Watts, 20 Watts*



**Info:** When the Search Watts feature is active “Search” appears on the bottom line of the LCD display, and the green INV LED will slowly flash.

**What is the Search Watts feature?** This feature is used to help save battery power by reducing the inverter’s output to search pulses when there is no detectable load. If someone turns on a load greater than the wattage level setting while the inverter is searching, the inverter will start inverting to provide full voltage on its output.

**Should I use the Search Watts feature?** If the inverter can spend a great deal of time searching (to reduce the power drain on your batteries) and you can tolerate small loads (less than 5 watts) from being on, then the Search Watts feature should be used. However, if you require some small loads (e.g., digital clocks, satellite receivers, answering machines, etc.,) to always be on, then this feature should be turned off (*SEARCH = Off*).

**Where to set:** The *SEARCH Watts* setting should be adjusted to the same power level (or the next lower setting) of the smallest load that you want to run. If you don’t know the wattage of the smallest load you want to run, turn the switch for the load on and then decrease the *SEARCH Watts* setting until the load comes on and stays on.

**Example:** You have reviewed all the loads you want to run and determined that the smallest load is a 20 watt light. Set *SEARCH = 20 Watt*. Whenever you turn on any load (because all the loads are greater than 20 watts), the inverter will stop searching and start inverting to deliver power to the load.



**Info:** Even though the Search Watts feature is on, some connected equipment may draw enough current even while turned off to keep the inverter in Invert mode.

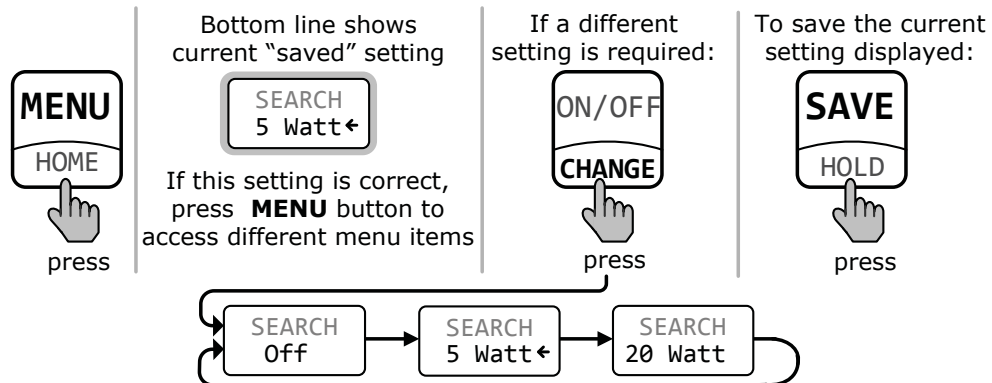

*Figure 3-3, Search Watts Selections*

## 3.0 Setup

### 3.3.3 Battery Amp-Hours Menu

- **BAT AHRS** – This selection is used to select the approximate capacity of the battery bank that is connected to the inverter (in battery amp-hours). This setting determines the time the battery charger is in the Absorb Charging stage (i.e., absorption time). See Table 3-2 to correlate the battery capacity to the absorption time.

**Default setting:** *BAT AHRS = 400 AH*

**Range:** *200 AH, 400 AH, 600 AH, 800 AH*

**Table 3-2, Battery Amp-Hrs to Absorb Charging Time**

Battery Amp-Hours Selected	Absorb Charging Time
Batt AmpHrs = 200	60 minutes
Batt AmpHrs = 400	90 minutes
Batt AmpHrs = 600	120 minutes
Batt AmpHrs = 800	150 minutes

**Where to set:** Select the setting based on the 20-hour Amp-Hour (AH) capacity of your battery bank.

**How do I determine my battery AH capacity?** The inverter requires deep cycle batteries, which are specifically made for continuous use. Deep cycle batteries are rated either by: a) amp-hours, or b) reserve capacity in minutes.

- Amp-Hour (AH) capacity is a measurement of how many amps a battery can deliver for a specified length of time (usually 20 hrs) until the voltage achieves 1.75 VDC/cell at 80°F (26°C).
- Reserve Capacity (RC) is a measure of how many minutes a battery can deliver a certain amount of current (usually 25A) while maintaining a voltage above 1.75 VDC/cell at 80°F (26°C).



**Info:** If using the Reserve Capacity (25A), the 20 hour AH capacity can be estimated by multiplying 'reserve capacity' by 50%.

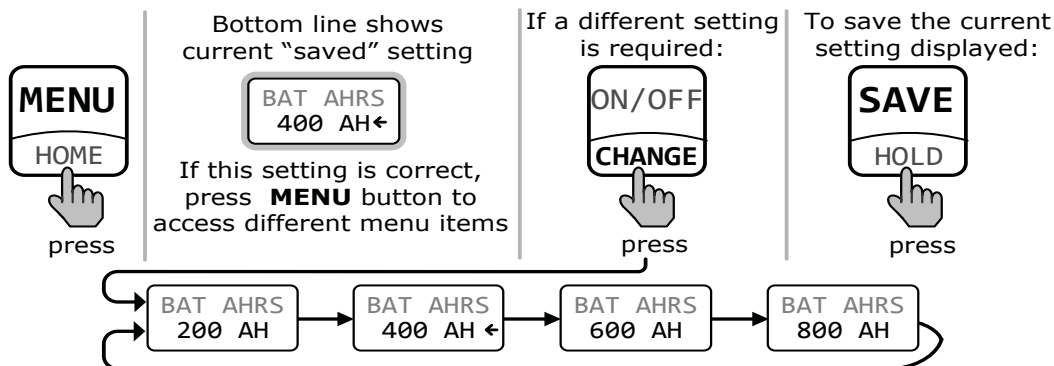

**Figure 3-4, Battery Amp-Hours Selections**

Table 3-3 on the facing page provides an estimated 20 hour AH capacity based on the group/code size, physical size, and the voltage of the battery. If you are not sure of your battery's 20 hour AH rating, consult your battery manufacturer/dealer or use Table 3-3 to obtain an estimate.



**Table 3-3, Battery Size to Battery Amp-Hours (estimated)**

Group/ Code Size	Physical Size (L" x W" X H")	Battery Voltage	Battery AHrs (20 hour rate)
GC-2 (Golf Cart)	10 3/8 x 7 13/16 x 10 5/8	6V	220 AHrs
L16	11 11/16 x 7 x 16 11/16	6V	375 AHrs
Group 22	9 1/2 x 6 7/8 x 8 5/16	12V	55 AHrs
Group 24	10 1/4 x 6 13/16 x 8 7/8	12V	70 AHrs
Group 27	12 1/16 x 6 13/16 x 8 7/8	12V	95 AHrs
Group 31	13 x 6 13/16 x 9 7/16	12V	110 AHrs
4D	20 3/4 x 8 3/4 x 9 7/8	12V	200 AHrs
8D	20 3/4 x 11 1/8 x 9 7/8	12V	225 AHrs

Once you've determined the AH capacity of each battery, review how your batteries are connected (parallel or series) to determine the total amp-hour capacity of the battery bank.

#### **Parallel connection**

When batteries are connected in parallel (positive to positive, negative to negative) they increase the amp-hour capacity of the battery bank, but the voltage remains the same.

**Example:** You have a 12v battery bank with three 12-volt batteries that are rated at 125 Amp-Hours (AH) each. Each of the positive terminals are connected together and each of the negative terminals are connected together, which means they are connected in parallel. The AHs of each battery connected in parallel are added together (125 AH + 125 AH + 125 AH = 375 AH), but the voltage of the battery bank stays the same (12 VDC).

#### **Series connection**

When batteries are connected in series (positive to negative) they increase the voltage of the battery bank, but the amp-hour rate remains the same.

**Example:** You have a 12-volt battery bank with two 6-volt batteries that are rated at 220 Amp-Hours (AH) each. The positive terminal of the first battery is connected to the negative terminal of the second battery, which means these batteries are connected in series. Since the two 6-volt batteries are connected in series, the voltage of the batteries are added together to produce 12-volts (6 VDC + 6 VDC = 12 VDC), but the amp-hour capacity of the battery bank does not change (220 AH).

In battery banks where you have batteries connected in series and in parallel—the rules are the same. The batteries connected in series are referred to as a "series string" and the amp-hour capacity doesn't change. Each series string is connected together in parallel to increase the amp-hour capacity. Add the amp-hour capacity of each series string connected in parallel to determine the total amp-hour capacity of the battery bank.



## 3.0 Setup

### 3.3.4 Battery Type Menu

- **BAT TYPE** – This setting selects the battery type, which determines the battery charge profile to ensure the batteries are receiving the proper charge voltage.

**Default setting:** *BAT TYPE = Flooded*

**Range:** *GEL, Flooded, AGM 1, AGM 2, LFP*

◆ **Battery Type (GEL, Flooded, AGM 1, or AGM 2)** – When the battery type selection is *GEL* (for Gel batteries), *Flooded* (for liquid lead acid batteries), *AGM 1* (for Lifeline AGM batteries), or *AGM 2* (for East Penn/Deka/Discover/Trojan AGM batteries), the charge voltage level for the Absorption, Float, and EQ charge modes are shown in Table 3-4—depending on the battery type selected and the nominal inverter battery voltage.

◆ **Battery Type (LFP)** – The LFP selection is provided to work specifically with lithium iron phosphate battery types and sets the charge voltage level as shown in Table 3-4—depending on the nominal inverter battery voltage.

When the *LFP* battery type has been selected, the charger begins Bulk charging whenever AC power is connected, and remains in the bulk charge stage until the absorption charge voltage is achieved. The charger will remain in the absorption charge stage until it is done, which is based on the Absorb Done: Time, Amps or SOC setting. After the absorption charge is done, the charger switches to the float charge mode, which allows the charge voltage to fall to the float voltage level. While float charging, the charger will provide the maximum rated current to the batteries in order to keep them fully charged and ready if needed by the inverter. The charger will remain in Float as long as the AC source is available on the input of the charger and the battery voltage is above the LFP rebulk level. If the voltage drops below the LFP rebulk level (>10 seconds), the charger restarts the Bulk and Absorption charge stages.



**Info:** If the LFP battery type has been selected, remove the BTS. Otherwise, the charge voltage level will change based on temperature changes around the BTS.



**Info:** When using the LFP battery type profile, the rebulk level  $\leq 12.8V$  (12-volt systems),  $\leq 25.6V$  (24-volt systems), or  $\leq 51.2V$  (48-volt systems) must be met for 10 seconds to rebulk.



**Info:** The LFP battery type selection forces the charger to go into the Bulk charge mode each time AC is connected. However, if AC is reconnected less than two minutes after being disconnected, the charger will return to the previous charge mode.

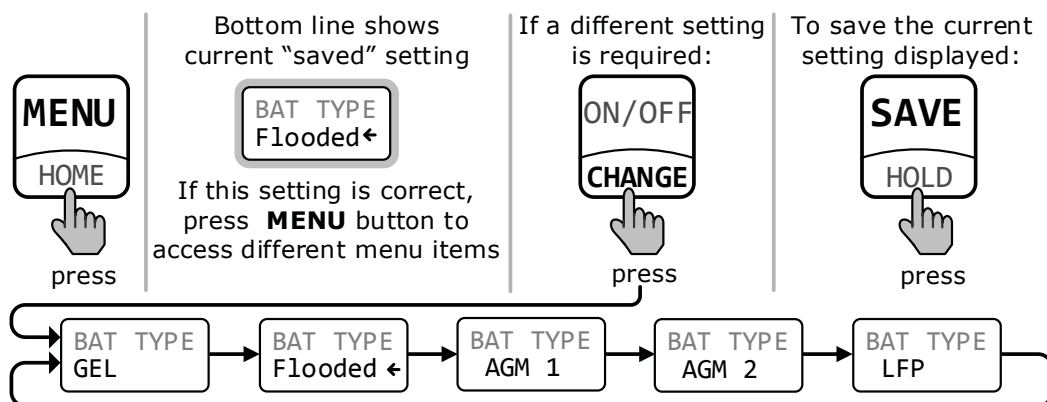

Figure 3-5, Battery Type Selections

Table 3-4, Battery Type to Charge Voltages

Battery Type	Inverter Voltage	Absorption Voltage	Float Voltage	Equalization Voltage
GEL	12 VDC	14.1 VDC	13.6 VDC	14.1 VDC <sup>1</sup>
	24 VDC	28.2 VDC	27.2 VDC	28.2 VDC <sup>1</sup>
	48 VDC	56.4 VDC	54.4 VDC	56.4 VDC <sup>1</sup>
Flooded	12 VDC	14.6 VDC	13.4 VDC	15.5 VDC
	24 VDC	29.2 VDC	26.8 VDC	31.0 VDC
	48 VDC	58.4 VDC	53.6 VDC	62.0 VDC
AGM 1 <sup>2</sup>	12 VDC	14.3 VDC	13.3 VDC <sup>4</sup>	15.5 VDC
	24 VDC	28.6 VDC	26.6 VDC <sup>4</sup>	31.0 VDC
	48 VDC	57.2 VDC	53.2 VDC <sup>4</sup>	62.0 VDC
AGM 2 <sup>3</sup>	12 VDC	14.5 VDC	13.5 VDC	14.5 VDC <sup>1</sup>
	24 VDC	29.0 VDC	27.0 VDC	29.0 VDC <sup>1</sup>
	48 VDC	58.0 VDC	54.0 VDC	58.0 VDC <sup>1</sup>
LFP	12 VDC	14.4 VDC	13.6 VDC	14.4 VDC <sup>1</sup>
	24 VDC	28.8 VDC	27.2 VDC	28.8 VDC <sup>1</sup>
	48 VDC	57.6 VDC	54.4 VDC	57.6 VDC <sup>1</sup>

**Note<sup>1</sup>:** Voltage same as absorption voltage—to prevent equalization charge.

**Note<sup>2</sup>:** Charge voltages for Concord (Lifeline Series) AGM batteries.

**Note<sup>3</sup>:** Charge voltages for East Penn, Deka, Discover and Trojan AGM batteries.

**Note<sup>4</sup>:** For inverter models <Level 5, the Float Voltage level is 13.1 VDC (12-volt models); 26.2 VDC (24-volt models); or 52.4 VDC (48-volt models). See Section 3.2 for inverter level information.



**CAUTION:** If using Lithium batteries and selecting the LFP battery type profile—to prevent the charger's output voltage level from changing based on temperature—REMOVE the BTS from the inverter.



**Info:** The charge voltage levels shown in Table 3-4 are with the Battery Temperature Sensor (BTS) at a temperature of 77° F (25° C), or not connected. If the BTS is connected, the actual charge voltage level will increase if the temperature around the BTS is below 77° F (25° C), and decrease if higher than 77° F (25° C). This ensures the batteries receive the correct charge voltage regardless of temperature.

## 3.0 Setup

### 3.3.5 Charge Rate Menu

- **CHG RATE** – This selection is used to set the maximum charge rate allowed to charge the batteries during Bulk, Absorption, Float, and Equalize charging. The *CHG RATE = 10%* setting is available to help minimize charging, while continuing to allow pass-through power.

**Default setting:** *CHG RATE = 100%*

**Range:** *10%, 50%, 100%*

The charge rate selections are provided as a percentage of the inverter/charger's maximum charging capability. Refer to the label on the side of the inverter or to the inverter/charger owner's manual to determine its maximum charge rate. Once you find this maximum charge rate, determine the percentage needed to limit the charge rate to your battery bank.

**Example:** If the maximum charge rate of your inverter/charger is 100 amps and you need to limit the charge rate to 50 amps, choose the *CHG RATE = 50%* selection (50 amps = 50% of 100 amps).

**Where to set:** The maximum charge rate is generally set to a C/5\* rate (C = total amp-hour capacity of the battery bank—using the 20 hr AH rate). The C/5 rate is usually used when the objective is to charge the batteries as quickly as possible (i.e., 400 AH ÷ 5 = 80 amp maximum charge rate). A lower rate such as C/20\* is used when the batteries need to be charged as slow as possible. The ME-MR provides three settings for charge rate adjustment—10, 50, and 100%. Multiply this percentage and the max charge rate of the inverter to find the closest setting to the desired charger output.



**CAUTION:** The C/5 or C/20 charge rate settings are guidelines; they are not requirements on how you should set your battery charge rate. For specific charge rate requirements, refer to your battery manufacturer.



**Info:** If multiple inverter/chargers are used on a single battery bank, you must ensure that the total charge rate from all inverter/chargers is limited to the max charge rate needed for your battery bank. This setting only limits the charging on each inverter/charger individually, not on all inverter/chargers.

\* C/5 or C/20 rate – Charge rates are commonly expressed as a ratio of the total amp-hour (AH) capacity of the battery bank. For example, with a 400 AH battery bank (C = 400), the C/5 charge rate is 80 A (400/5 = 80 A).

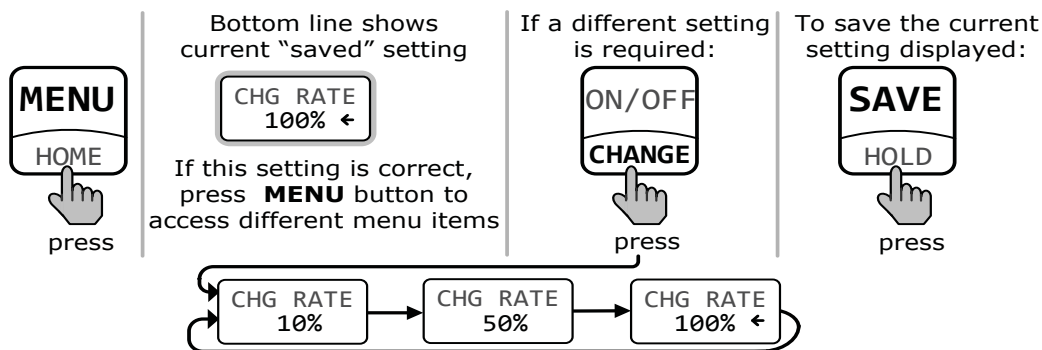

**Figure 3-6, Charge Rate Selections**

### 3.3.6 Low Battery Cut-Out (LBCO) Menu

- LBCO** – This menu is used to set the battery voltage level that turns the inverter off to help protect the batteries from over-discharge damage. Selections are from 9 VDC to 11 VDC (12-volt inverter models), 18 VDC to 22 VDC (24-volt inverter models), or 36 VDC to 44 VDC (48-volt inverter models). If the battery voltage drops below the LBCO selected setpoint continuously for more than one minute, the FAULT LED will come on, the inverter will turn off, and the display shows "FAULT! Low Bat" (low battery status). If the battery voltage falls below 8.5 volts (12-volt models), 17.0 volts (24-volt models) or 34.0 (48-volt models), the FAULT LED and Low Bat status will be immediate.

**Default settings:** LBCO = 10.0 VDC (12-volt models), 20.0 VDC (24-volt models) or 40.0 VDC (48-volt models).

**Range:** 9.0 VDC, 10.0 VDC, 11.0 VDC, 13.0 VDC (12-volt models); 18.0 VDC, 20.0 VDC, 22.0 VDC, 25.5 VDC (24-volt models); 36.0 VDC, 40.0 VDC, 44.0 VDC, 51.0 VDC (48-volt models).



**Info:** If the inverter shuts down from a LBCO fault, this fault will automatically be cleared when the battery voltage increases to the LBCI (Low Battery Cut In) level. The inverter's LBCI level is determined by the LBCO setting. If the LBCO is 13.0\*, the unit recovers when  $V_{bat} \geq 13.4V$ ; if the LBCO is  $\leq 11.0V^*$ , the unit recovers when  $V_{bat} \geq 12.5V^*$ .

\* These are 12V values; they are different for 24V and 48V inverters.

**Where to set:** For Lead Acid battery types (e.g., Flooded, GEL, and AGM); if you want to cycle the batteries slightly—but don't want to discharge them more than 20%\*—then the LBCO setting should be from 11.5-12.2 VDC (12-volt models), 23.0-24.4 VDC (24-volt models), or 46.0-48.8 (48-volt models). In some applications, such as an off-grid home or when doing a lot of dry-camping in your RV, you may want to cycle down to 50%\* by setting the LBCO from 10.0-11.4 VDC (12-volt models), 20.0-22.8 VDC (24-volt models), or 40.0-45.6 VDC (48-volt models). In extreme circumstances, you have the ability to discharge the batteries to 80%\* by setting the LBCO to 9.0-9.5 VDC (12-volt models), 18.0-19.0 VDC (24-volt models), or 36.0-38.0 VDC (48-volt models) before recharging.

\* These discharge percentages are rough estimates; for accurate battery monitoring, a battery monitor such as Magnum's ME-BMK and a ME-RC or ME-ARC remote is required.

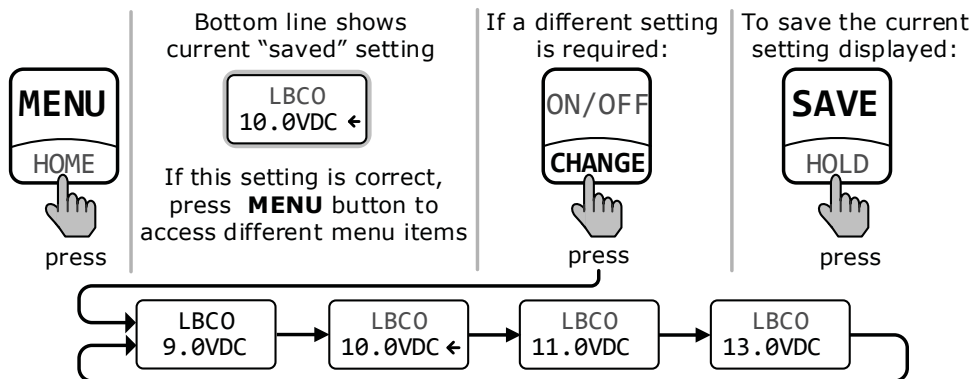

**Note:** Values shown are for a 12-volt inverter

Figure 3-7, LBCO: Low Battery Cut-Out Selections

## 3.0 Setup

### 3.3.7 VAC Dropout Menu

- **VAC DROP** – This selection is used to set the minimum AC voltage that must be present on the input before the inverter/charger switches from Invert to Charge mode. For example, if this setting is set to *VAC DROP = 60 VAC*, then the AC input voltage must be above 60 volts before the inverter will switch from Invert mode to Charge mode. This setting also determines the minimum AC voltage threshold where the inverter/charger transfers from the AC input (utility/shore or generator) and begins inverting. This protects AC loads from utility outages.

**Default setting:** *VAC DROP = 80 VAC* for North American units; *150 VAC* for export models.

**Range:** *60 VAC*, *80 VAC*, and *100 VAC* for 120-volt units (North America); or *110 VAC*, *150 VAC*, and *190 VAC* for 230-volt export units.

**Where to set:** It depends on the application and what you are using as the AC source. The settings not only look at the incoming voltage to determine when to transfer, but they also determine the response sensitivity to incoming voltage fluctuations. Use the 100 VAC dropout setting when the AC source is well regulated and you are operating devices that are sensitive to voltage fluctuations. Use the 80 VAC or lower setting (60 VAC) when the AC source may have significant fluctuations in RMS voltage. These settings are highly recommended if using a generator for charging.

**Note:** If the ME-MR is connected to a dual source inverter (i.e., MSH4024RE), the VAC Dropout setting applies to both inputs (AC1 and AC2).

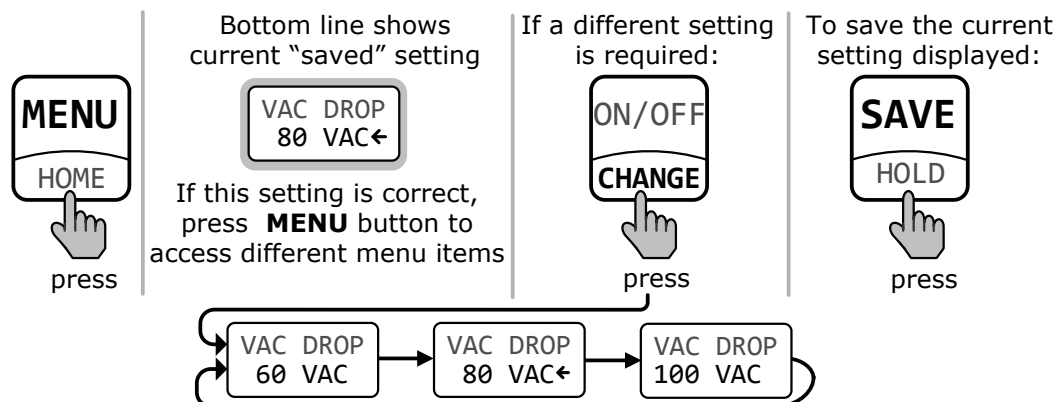

Figure 3-8, VAC Dropout Selections

**3.3.8 Power Save Menu**

- **PWR SAVE** – This setting allows you to turn the Power Save feature on or off.

**Default setting:** *PWR SAVE = On*

**Range:** *On, Off*

**What is the Power Saver feature?** The Power Saver feature causes the LCD backlight and LEDs on the remote display to turn off to conserve energy. The remote goes into Power Saver mode if there has not been a button press or fault message for 15 minutes. Whenever the remote goes into the Power Saver mode, the LCD backlight and LEDs can be reactivated by pressing any button on the remote.

If a fault occurs during Power Saver mode, the LCD backlight and the FAULT LED will come on and stay on as long as the fault is detected. If you want the LCD backlight and LEDs to always be on, select *PWR SAVE = Off*.

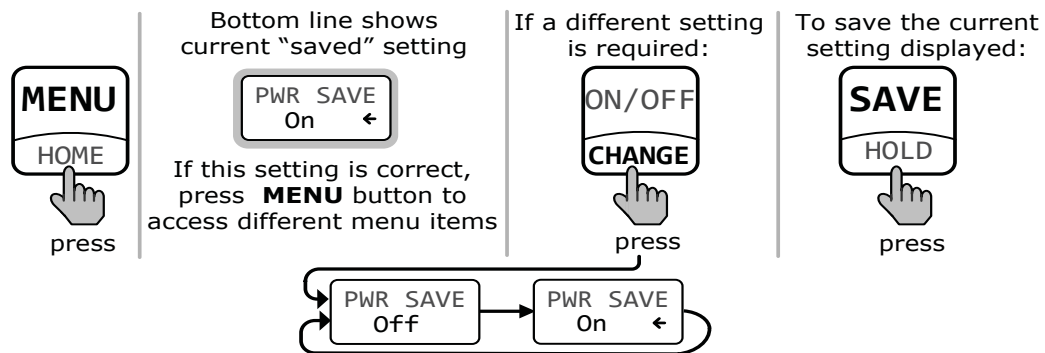

*Figure 3-9, Power Saver Selections*

## 3.0 Setup

### 3.3.9 Equalize Menu

- **EQUALIZE** – This menu allows you to enable equalize charging. Equalize charging (or equalizing) is a controlled overcharge of the batteries. It helps to mix the battery electrolyte and attempts to reverse the build-up of stratification by removing sulfates that may have built up on the plates. These conditions if left unchecked, reduce the overall capacity of the battery bank.

**Default setting:** *EQUALIZE = Disabled*

**Settings:** *Disabled, Request, EQing*

**How do I enable equalize charging?** Equalization charging can only be enabled while the charger is in Float Charge or Full Charge. To enable, press the MENU button until you see the “Disabled” menu, then press the CHANGE button. The display quickly reads “Request”, then “EQing.”

The Equalize Charge lasts for four hours, and then automatically stops and returns to Float Charging. The Equalize Charge can be manually stopped by pressing the MENU button until you see the “EQing” menu, and then pressing the CHANGE button until the display reads “Disabled”.

**How often should I equalize?** Some experts recommend that heavily used batteries should be equalized periodically, ranging anywhere from once a month to once or twice per year. Other experts only recommend equalizing when the cells have a low specific gravity reading, or when the difference between any individual cell has a reading  $>.015$  after being fully charged.

**How long should I equalize?** While the batteries are gassing, monitor the specific gravity readings every hour. When the specific gravity readings no longer increase, the Equalization charge is complete and should be stopped.



**WARNING:** Do not perform an Equalization charge without reading and following all safety precautions pertaining to charging/equalization as noted in this manual and provided by the battery manufacturer, and any equalization information in the inverter owner’s manual.



**CAUTION:** Ensure your batteries can be equalized—only equalize your batteries if permitted by your battery manufacturer. Performing an Equalize Charge on batteries other than liquid lead acid or certain AGM types could permanently damage them. Refer to your battery manufacturer on how to properly equalize your batteries.



**Info:** Equalization charging is not available if either *GEL*, *AGM 2*, or *LFP* is selected from the *Battery Type* menu.

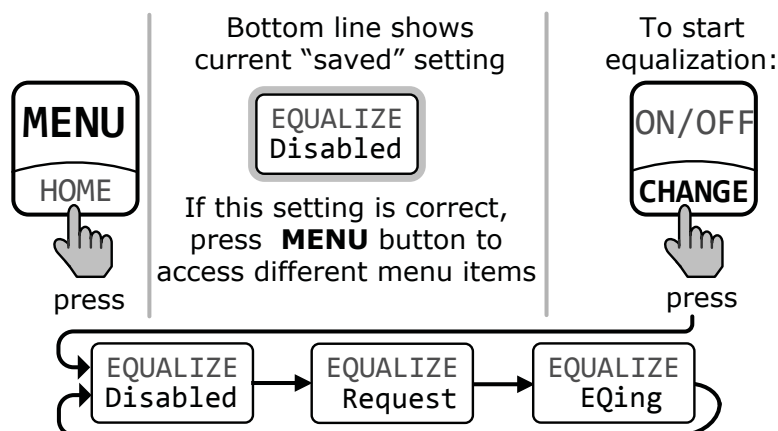

Figure 3-10, Equalize Selections



### 3.3.10 Charger Standby Menu

- **CHARGER** – Select whether to activate Charger Standby mode after AC power is connected (charger ready and waiting for AC input).

**Default setting:** *CHARGER = No AC In*

**Range:** *No AC In, Chg Stby*

**What is Charger Standby?** When the charger is in Charger Standby, the incoming AC is still available on the inverter’s output, but the charger is not allowed to charge.



**Info:** To resume charging, access the Charger Standby menu and press the CHANGE button.



**Info:** If upon accessing this menu “No AC In” displays, you will not be able to change the Charger’s status.

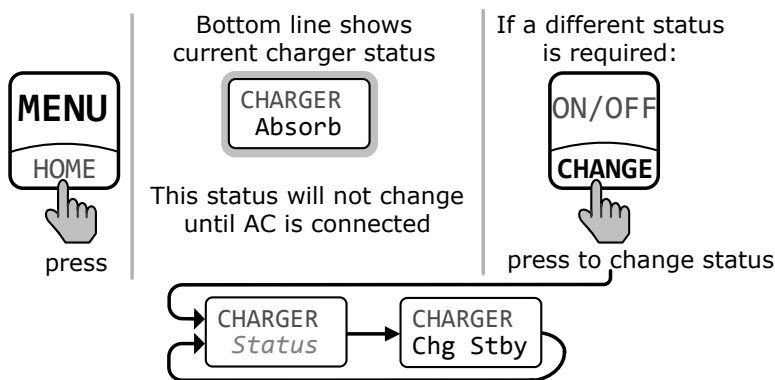

Possible statuses:  
*Absorb, Bulk, Charging, Equalizing (EQing), Float, Full Charge (Full Chg), Load Support AAC (LS AAC), Load Support VDC (LS VDC)*

**Figure 3-11, Charger Standby Selections**

### 3.3.11 Power On Menu

- **POWER ON** – Select whether to have the inverter power up and provide AC power automatically once DC voltage is connected to it.

**Default:** *POWER ON = Norm*

**Range:** *Norm (Normal), Always*

**What is the Power On feature?** Normally, when DC power is connected to the inverter, the user is required to press the power button—on the inverter or remote—to turn the inverter on (*Norm*). When the Power On feature is activated by selecting *Always*, the inverter is automatically turned on and starts searching or inverting—depending on the *Search Watts* setting (see Section 3.3.2). Once the inverter has connected to DC power and is automatically turned on, the power button—on the inverter or remote—can be used to turn the inverter on or off.

**Why use the Power On feature?** Some customers are familiar with Uninterruptible Power Supplies (UPS) that power-up automatically when DC power is connected. The Power On feature can be used by customers that want to obtain the same automatic power-up feature with which they are familiar.



## 3.0 Setup

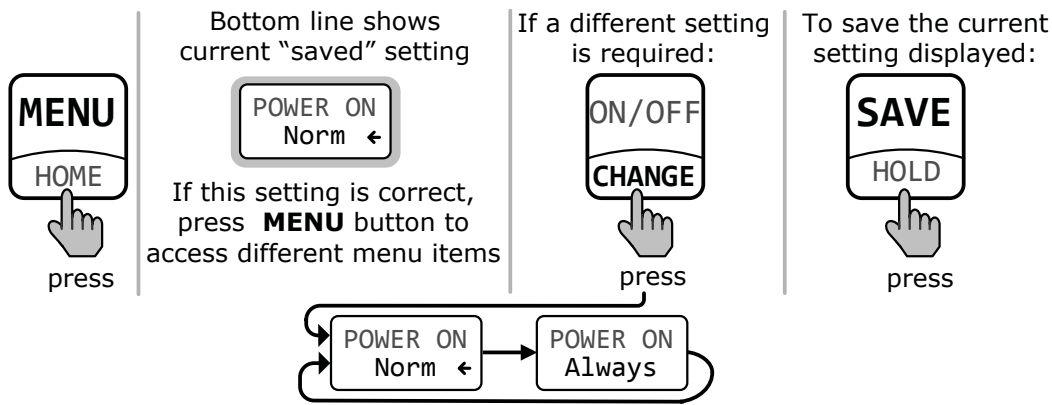

Figure 3-12, Power On Selections

### 3.3.12 TECH Menu

- **TECH** – This menu provides access to read only system information that can assist service technicians in troubleshooting. It also offers a selection that enables you to return all system settings to the original factory default values, and another that locks some setup menus.

Scroll to the end of the remote's menus until "TECH, Press ON" appears. Press the ON/OFF CHANGE button to access these selections. Continue to press the ON/OFF CHANGE button to view each TECH menu item.

- **Bat Temp:** Displays the temperature of the battery temperature sensor (BTS)—if connected.
- **Xfm Temp:** Displays the temperature of the inverter's transformer.
- **FET Temp:** Displays the temperature of the FETs (Field Effect Transistors).
- **Inverter Rev:** Displays the firmware revision level of the inverter.
- **Remote Rev:** Displays the firmware revision level of the remote.
- **Model:** Displays the model number of the connected inverter.



**Info:** If "Model Unknown" displays, the remote is unable to determine the inverter model. This may be due to an inverter revision newer than the remote. All remote menu selections/features that are available in the inverter will function normally.

- **Ext Ctrl:** Magnum has an open protocol policy that allows certain functions (*AC In*, *Charge Rate*, & *VAC Dropout* settings) of the inverter/charger to be controlled externally—such as with a third party communications device.

**No** – there is no external device controlling any of the inverter's settings.

**INT** – an external device is controlling the setting—however, the external device has not changed the setting at this time.

**EXT** – an external device is controlling the setting—and, the external device has changed the setting.

When an external device is connected, the above menus scroll across the bottom line of the display. The *INT* or *EXT* display denotes whether the setting has been changed. **Example:** *AC IN INT...CHR% INT...VAC EXT*. An external device is connected, the *AC IN* and *Charge Rate* settings have not been changed, but the *VAC Dropout* setting has been changed.

- **SETUP:** Allows you to *Lock* or *Unlock* the setup menus on your remote. Press the SAVE/HOLD button to lock the setup menus (*Lock*) or to unlock (*Unlock*) the setup menus.

**Note:** Exception – *AC In* menu *does not* lock.

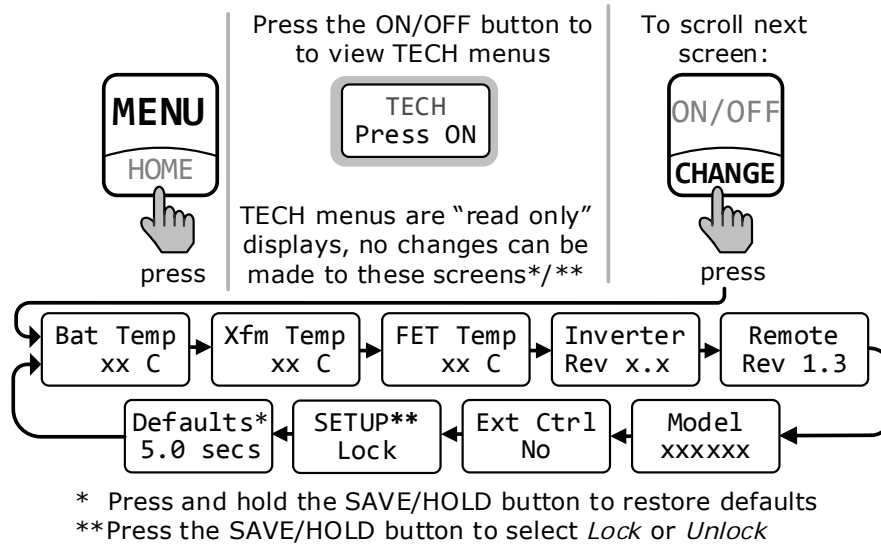

**Figure 3-13, TECH Menus**

- Defaults:** This menu restores (or loads) all settings in the ME-MR (and in the connected inverter/charger) to the factory default settings. To load, scroll to the DEFAULTS menu, then press and hold the SAVE/HOLD button until the display counts down from 5.0 to 0.0 seconds. After 5 seconds, the display will show "Loaded" once the default settings have been restored. The ME-MR factory defaults are listed in Table 3-5.

**Table 3-5, ME-MR's Inverter/Charger Default Settings**

Menu	Default Setting
AC In	AC IN = 30 Amps*
Search Watts	SEARCH = 5 Watt
Battery Amp-Hours	BAT AHRS = 400 AH (Absorb Time = 90 min.)
Battery Type	BAT TYPE = Flooded
Charge Rate	CHG RATE = 100%
Low Battery Cut Out	LBCO = 10 VDC (12-volt models), 20 VDC (24-volt models), 40 VDC (48-volt models)
Low VAC Dropout	VAC DROP = 80 VAC (150 VAC for export)*
Power Save	PWR SAVE = On (15 min.)
Equalize	EQUALIZE = Disabled
Charger Standby	CHARGER = No AC In (Charger Standby is off, will automatically charge when AC is connected)
Power On	POWER ON = Norm
TECH: SETUP	SETUP = Unlock

\* - If using a dual-source model inverter (which has two AC source inputs), both the AC1 and AC2 inputs have the same default setting. The AC IN setting = 30 Amps and the VAC DROP setting = 80 VAC).

## 4.0 Menu Map

### 4.0 Menu Map: ME-MR Remote Control

This menu map is an overview of the inverter/charger settings (arrows denote factory defaults) and the info displays available from the ME-MR.

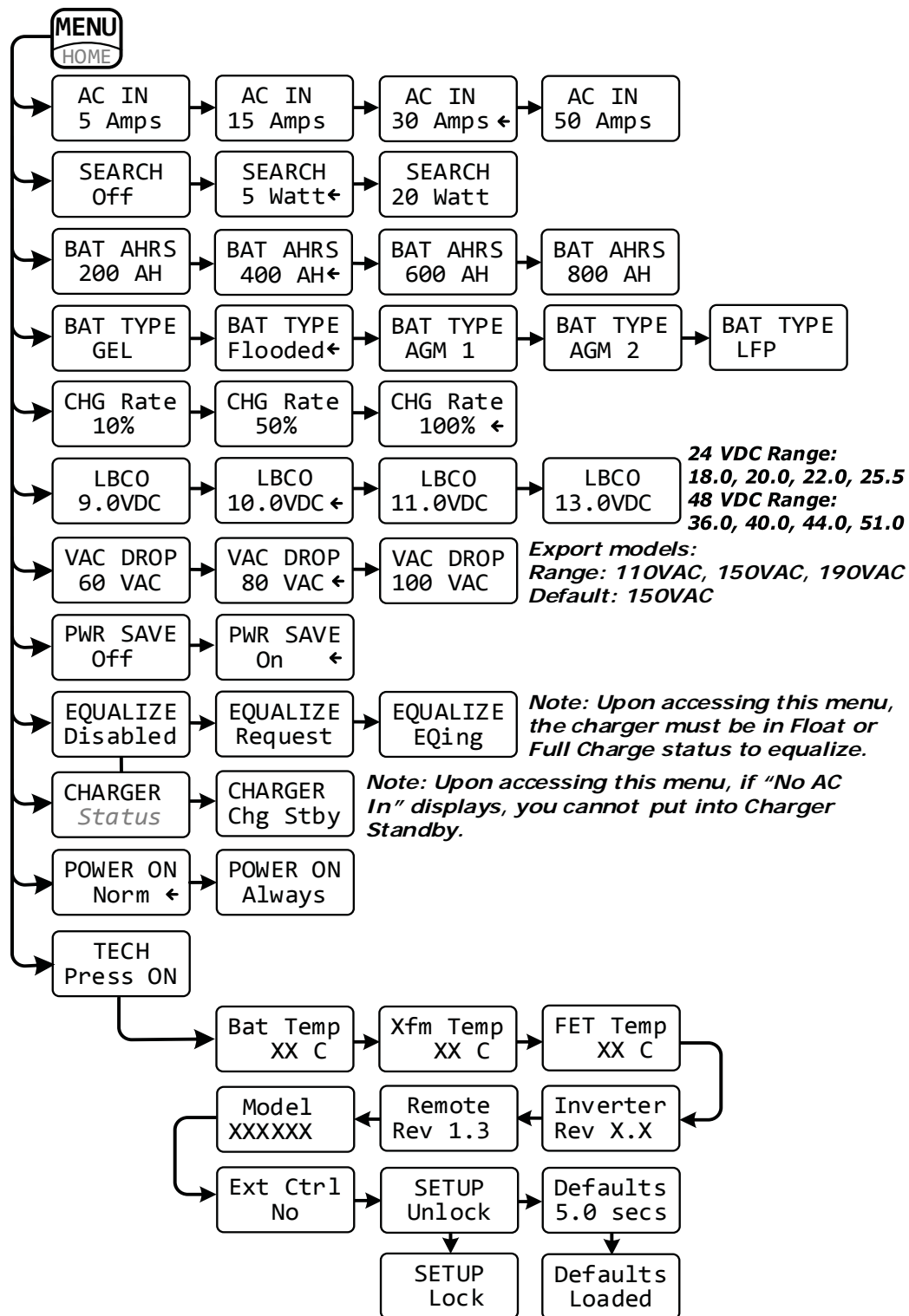

Figure 4-1, ME-MR Remote Menu Map

## 5.0 Operation

This section gives a brief overview of the ME-MR remote's LED indicators, LCD display, and available buttons. It also covers how to operate an inverter/charger using the remote, and the various status and fault messages that may display during operation.

### 5.1 Front Panel

The ME-MR front panel contains two LEDs and a LCD display for viewing system status, and three buttons to control system operation.

#### 5.1.1 LED Indicators

The two LED indicators on the front panel illuminate solid or blink to indicate the inverter/charger's status. When the remote is first powered up, both LEDs come on as it goes through a self-test. Once the self-test is complete, the LEDs and the LCD display provide the operating status of the inverter/charger. See Section 5.3.4 for the LED Indicator Guide.

#### 5.1.2 LCD Display

The LCD display is used for setting up the system operation as well as viewing the current operating status—or any fault condition that may occur. This display has two lines of alphanumeric characters and features a backlight that can be set to turn off to conserve power. The top and bottom lines display the inverter/charger's status, setup menus, and any TECH read only information. When the remote is powered up, the display automatically scrolls through the Home screens showing the inverter/charger status and the battery voltage and current (see Figure 3-1).

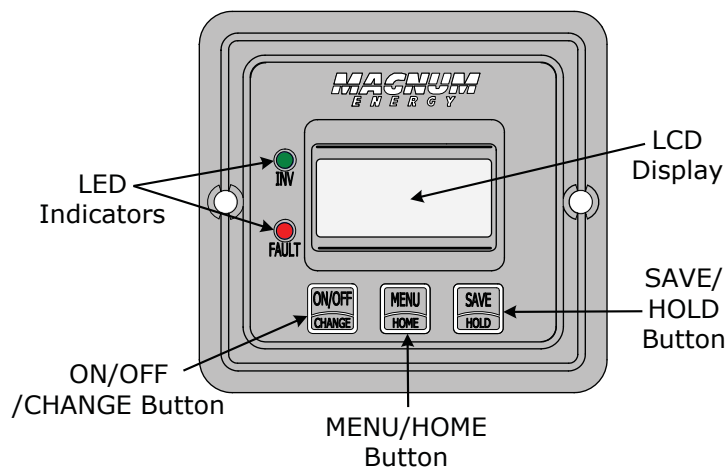

*Figure 5-1, ME-MR Front Panel Controls and Indicators*

#### 5.1.3 ME-MR Remote Buttons

##### ON/OFF Button

This button toggles the inverter function on and off. The green INV LED turns on and off with the button.

##### MENU Button

This button provides quick access to menu items that can help with configuring, monitoring, and troubleshooting your inverter/charger.

##### SAVE Button

This button saves the changes to settings selected in the remote's menus.

## 5.0 Operation

### CHANGE Button

This button scrolls through the selections available under each menu heading. Each menu restarts, so if you missed the desired selection, simply continue to press the MENU button until the desired selection reappears.

### HOME Button

Hold down the HOME button for two seconds to return to the Home screens.



**Info:** The MENU/HOME button can be used to reset the remote by pressing and holding it down for 10 seconds. This is useful if the display shows unrecognizable letters or symbols.

### HOLD Button

Hold down this button for two seconds to stop the Home screens from scrolling. Hold down again to restart the scrolling of the Home screens.



**Info:** All adjustable inverter/charger settings in the ME-MR are saved in non-volatile memory and are preserved until changed—even if an inverter reset is performed (see Section 6.2), or if all power to the remote or inverter is removed.



**Info:** The ME-MR remote is only used to control an inverter. In order to control or display a Magnum Energy accessory, you need to use a ME-RC50 or ME-ARC50 remote control. Please refer to the particular remote control owner's manual at [www.SensataPower.com](http://www.SensataPower.com) for further information on displaying accessories.

## 5.2 Operating the Inverter/Charger

**Turning the inverter on** – Press the ON/OFF button to activate the inverter. The inverter will either search for a load—using very little power from the batteries—if in Search mode (see Figure 5-5), or actively inverting—using battery power to power the AC loads (see Figure 5-3). The green INV LED is on when the inverter is actively inverting, and flashes when searching.

**Turning the inverter off** – While the inverter is actively inverting or searching, the ON/OFF button can be pressed to switch the inverter function off, and this will turn the green INV LED off (see Figure 5-4).

**Inverter Standby** – The inverter is in standby when it is active (green INV LED is on) and the remote shows a charge status due to an external AC power source (utility/shore or generator) passing through the inverter to power the AC loads. During normal operation, the AC loads are powered by the external AC power source. However, if a blackout or brownout condition occurs the inverter senses these conditions, transfers to Inverter mode, and then powers the AC loads connected to the inverter.



**CAUTION:** If you have critical loads and are in Inverter Standby, do not press the ON/OFF button to turn the inverter off. If the green INV LED is off, inverter power will NOT be available to run your critical loads should the external AC power be interrupted.

**Equalize charging** – Equalizing is a controlled overcharge performed after your flooded (or AGM 1 type) batteries have been fully charged. It mixes the battery electrolyte (to reverse stratification) and removes sulfation that may have built up on the plates. These conditions, if left unchecked, reduce the overall capacity of the battery.



**WARNING:** Do not perform an equalization charge without following all safety precautions pertaining to equalization—as noted in this manual (see pages 17 and 27) and in the inverter owner's manual.

### 5.3 System Status Messages

The remote control uses the bottom line of the LCD display to show the inverter/charger's operation by displaying a status message. This section will review the inverter/charger's operating modes and the available status messages under each mode. Use these messages along with the status LEDs to determine the inverter/charger's current operating status, and to assist in troubleshooting the system if a fault occurs.

There are three operating modes of the inverter/charger:

- Inverter Mode
- Charger Mode
- Fault Mode

#### 5.3.1 Inverter Mode Messages

The inverter/charger is in Inverter mode when connected to a battery bank and AC power (shorepower/utility or generator) is not available, or is unacceptable to the inverter/charger's input. The Inverter mode messages are *Inverter Standby*, *Inverting*, *Off*, and *Searching*.

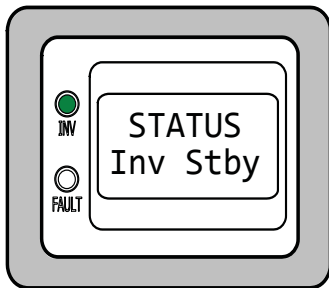

**Inv Stby** appears on the LCD. The INV (green) LED is on solid. The FAULT (red) LED is off.

*Figure 5-2, Inverter Standby*

- **Inverter Standby** – The inverter is on but not actively providing power. However, the inverter remains active and external AC power (utility or generator) is passing through the inverter to power the AC loads.

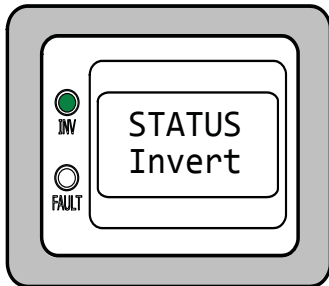

**Invert** appears on the LCD. The INV (green) LED is on solid. The FAULT (red) LED is off.

*Figure 5-3, Inverting*

- **Inverting** – The inverter is providing AC voltage on its output by inverting power from the batteries.

## 5.0 Operation

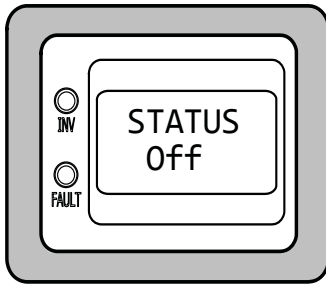

**Off** appears on the LCD. All LEDs are off.

**Figure 5-4, Off**

- **Off** – This message tells you that there is no AC available on the inverter's AC output. The inverter function is off.

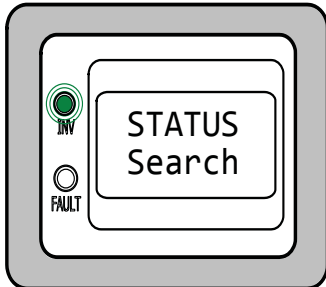

**Search** appears on the LCD. The INV (green) LED slowly flashes. The FAULT LED (red) is off.

**Figure 5-5, Searching**

- **Searching** – When the inverter is in the Search mode, the AC loads on the inverter output are less than the *Search Watts* setting. The Search function is used to reduce the inverter draw from the battery, and may be turned off whenever you want full inverter output voltage available at all times.

### 5.3.2 Charger Mode Messages

When AC power (utility or generator) is connected to the inverter/charger, it begins to monitor the AC input for acceptable voltage. Once the AC input is accepted, the AC transfer relay (inside the inverter) closes and Charge mode begins. There are several Charge mode messages; view the LCD display and the corresponding message in this section to identify and understand the particular Charge mode.



**Info:** The AC input becomes acceptable after a minimum 10-second delay, and when the voltage is greater than the *VAC Dropout* setting.

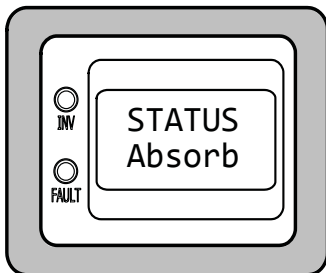

**Absorb** appears on the LCD. The FAULT (red) LED is off, and the INV (green) LED could be on or off.

**Figure 5-6, Absorb Charging**

- **Absorb Charging** – The Absorb stage is the constant voltage stage and begins when the absorb voltage is reached (determined by the *Battery Type* setting) while Bulk Charging. During this stage, the DC charging current decreases as the battery becomes charged. This Charge stage continues until the absorb charging time (determined by the *Battery Amp-Hours* setting) is finished.

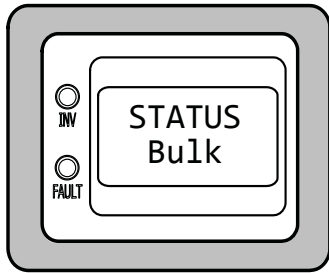

**Bulk** appears on the LCD. The FAULT (red) LED is off, and the INV (green) LED could be on or off.

*Figure 5-7, Bulk Charging*

- **Bulk Charging** – The battery charger is delivering maximum current (determined by the *Charge Rate* setting) to the batteries. The charger remains in Bulk Charge until the absorb voltage (determined by the *Battery Type* setting) is reached.

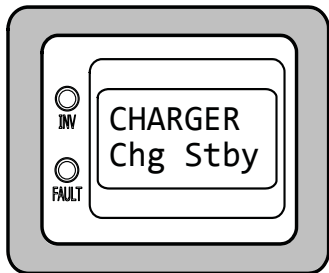

**Chg Stby** appears on the LCD. The FAULT (red) LED is off, and the INV (green) LED could be on or off.

*Figure 5-8, Charger Standby*

**Charger Standby** – The charger is disabled to prevent any charging, but the AC power to the AC input is still available on the AC output.



**Info:** Press the CHANGE button to turn the charger on. See Section 3.3.10 for more information on Charger Standby.

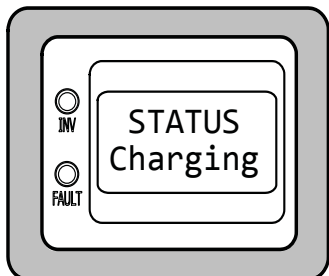

**Charging** appears on the LCD. The FAULT (red) LED is off, and the INV (green) LED could be on or off.

*Figure 5-9, Charging*

- **Charging** – Once Charge mode has been enabled, the unit waits and displays “Charging” to determine the charge routine. If the battery voltage is low ( $\leq 12.8$  VDC/12-volt models,  $\leq 25.6$  VDC/24-volt models, or  $\leq 51.2$  VDC/48-volt models), the charger initiates Bulk Charging. If the DC voltage is higher than this voltage, the charger skips the Bulk and Absorb Charging stages and goes directly to Float Charging.



**Info:** If the LFP battery type has been selected, the charger will go into the Bulk charge mode each time AC is connected—regardless of the battery voltage. However, if AC is reconnected less than two minutes after being disconnected, the charger will return to the previous charge mode.



## 5.0 Operation

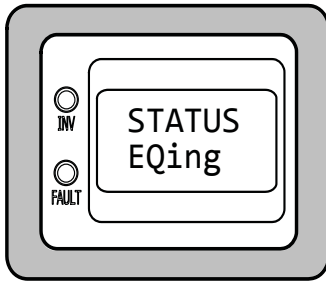

**EQing** appears on the LCD. The FAULT (red) LED is off, and the INV (green) LED could be on or off.

**Figure 5-10, Equalizing**

- **Equalizing** – The battery charger is delivering the equalize voltage to the batteries. Refer to Table 3-4 to determine the equalize voltage. Refer to Section 3.3.9 for important information on equalizing.



**WARNING:** Equalizing produces excessive hydrogen and oxygen gas. This condition is not only corrosive, but can also be dangerous. Ensure the battery compartment can divert these gases away from the inverter to prevent corrosion; and has adequate ventilation to dissipate these gases in order to avoid explosions.



**CAUTION:** During the Equalize Charge stage the batteries will begin gassing and bubbling vigorously, which consumes water. Ensure each cell has adequate distilled water levels prior to equalizing, and add water as needed after equalizing.



**CAUTION:** If there are DC loads connected to your batteries, ensure they will not be damaged by the higher voltage applied during the Equalize Charge. If in doubt, disconnect the DC loads.



**Info:** Equalization is not allowed if *GEL*, *AGM 2*, or *LFP* is selected from the *Battery Type* menu.

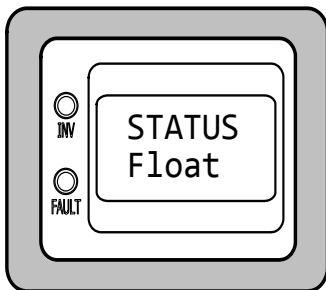

**Float** appears on the LCD. The FAULT (red) LED is off, and the INV (green) LED could be on or off.

**Figure 5-11, Float Charging**

- **Float Charging** – At the end of the Absorb Charging stage, the charger reduces the charge voltage and tries to maintain the batteries at the Float Charge voltage setting—which is determined by the *Battery Type* setting. See Table 3-4.



**Info:** Unless the Silent mode is enabled, when the battery voltage falls  $\leq 12.1$  VDC (12-volt models),  $\leq 24.2$  VDC (24-volt models) or  $\leq 48.4$  VDC (48-volt models), the unit will begin Bulk Charging.

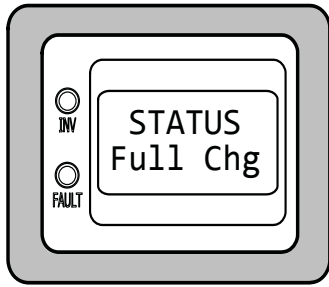

**Full Chg** appears on the LCD. The FAULT (red) LED is off, and the INV (green) LED could be on or off.

*Figure 5-12, Full Charge*

- Full Charge** – This status indicates that you have entered the Battery Saver™ mode. This mode maintains the batteries without overcharging, thus preventing excessive loss of water in flooded batteries or drying out of GEL/AGM batteries. After 4 hours Float Charging, the charger turns off and “Full Chg” displays (charger is now in Battery Saver™ mode). If the battery voltage drops to  $\leq 12.6$  (12-volt models),  $\leq 25.2$  (24-volt models) or  $\leq 50.4$  (48-volt models), the charger automatically initiates another 4 hours of Float Charging. This cycle helps to ensure the batteries are monitored and maintained, and continues as long as AC power is continuously connected to the AC input.

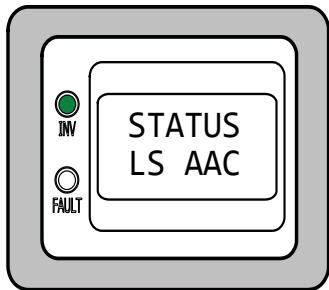

**LS AAC** appears on the LCD. The FAULT (red) LED is off, and the INV (green) LED is on.

*Figure 5-13, Load Support AAC*

- Load Support AAC** – The inverter is in Load Support (Amps AC) mode because the inverter load is requiring more power than the incoming AC source can provide on its own. The inverter pulls the additional current—needed for the loads—from the batteries to keep the incoming AC current from exceeding the *AC IN* setting.



**Info:** Load Support operates in parallel with the AC input to support the inverter loads and is only available on MSH Series inverters. It is only active when the inverter is enabled (INV LED is on).



**Info:** When the inverter is in Inverter Standby mode (charging and pass-thru), the current is normally a positive value. However, in Load Support AAC mode, the inverter amps reading is a negative number to indicate how much current is being provided/removed from the inverter batteries. The inverter batteries will continue to provide current to assist the AC input current as long as the battery voltage stays 0.5 volts above the *LBCO* setting.

## 5.0 Operation

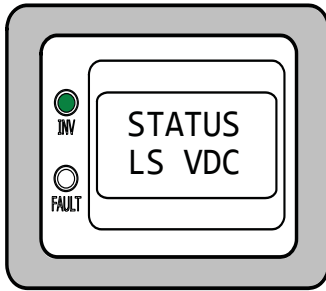

**LS VDC** appears on the LCD. The FAULT (red) LED is off, and the INV (green) LED is on.

*Figure 5-14, Load Support VDC*

- **Load Support VDC** – The inverter/charger is in Load Support (Volts DC) mode because an external DC source (solar, wind, etc.,) is providing more current than needed—which causes the battery voltage to rise. The inverter/charger reduces the incoming AC current in an effort to keep the battery voltage from rising above the temperature-compensated *Battery Type* setting.



**Info:** The Load Support VDC feature operates in parallel with the AC input to support the inverter loads and is only available on MSH Series inverter/chargers. This feature is only active in the Absorb or Float Charge modes and when the inverter is enabled (INV LED is on); it is deactivated if the charger is in Charger Standby.

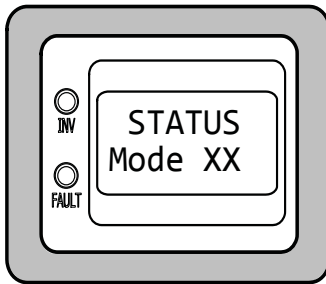

**Mode XX** appears on the LCD. The FAULT (red) LED is off, and the INV (green) LED could be on or off.

**Note:** *XXs are just placeholders for the actual characters that appear.*

*Figure 5-15, Unknown Mode*

- **Unknown Mode XX** – The remote doesn't recognize the mode the inverter is reporting. Contact Magnum Technical Support (425-353-8833) for assistance.

### 5.3.3 Fault Mode Messages

When an abnormal condition is detected, the FAULT LED comes on and a fault status is displayed. View the LCD display and use the information in this section to identify and correct the issue.



**Info:** Many faults automatically restart once cleared. Some require either a manual restart or an inverter reset. See Section 6.2.

#### 5.3.3.1 System Fault Messages

These fault messages are usually caused by some external issue that directly affects the inverter/charger system.

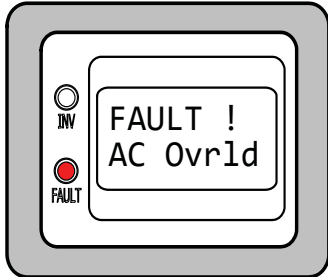

**AC Ovrld** appears on the LCD and the FAULT (red) LED is on. The INV (green) LED is off.

*Figure 5-16, AC Overload Fault*

- **AC Overload Fault** – The AC load on the inverter/charger’s output exceeds the inverter’s AC current protection limits. If the overload condition lasts for less than 10 seconds, the unit automatically restarts and resumes operation. However, if the overload occurs for longer than 10 seconds, the unit shuts down and requires a manual restart.



**Remedy:** This fault occurs because: the connected AC loads are larger than the inverter’s output capacity, there is a wiring short on the output, or the output wires are incorrectly installed. Once the AC loads are reduced or the output wiring is corrected, the inverter can be restarted after a manual restart has been accomplished.

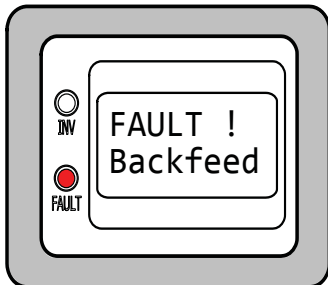

**BackFeed** appears on the LCD and the FAULT (red) LED is on. The INV (green) LED is off.

*Figure 5-17, BackFeed Fault*

- **BackFeed Fault** – The inverter shuts down because AC voltage from an external AC source has been detected on the inverter’s AC output. When the unit shuts down because of this fault condition, an inverter reset is required in order to resume operation (see Section 6.2 to reset the inverter).



**Remedy:** This fault usually occurs because the AC output wiring is connected to (or able to be connected to) the incoming AC source. When this fault happens, all system wiring should be re-checked to ensure the incoming hot and and/or neutral wires are not able to be connected to the AC output.

## 5.0 Operation

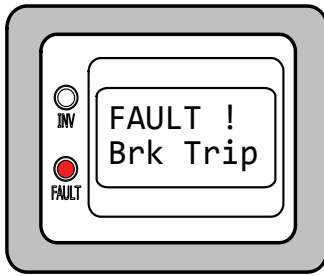

**Brk Trip** appears on the LCD and the FAULT (red) LED is on. The INV (green) LED is off.

*Figure 5-18, Breaker Tripped Fault*

- **Breaker Tripped Fault** – The inverter has detected that the AC input circuit breaker (CB1) on the inverter/charger has opened due to excess current flow through the inverter to the AC loads.



**Remedy:** After reducing the AC loads, push in the inverter's AC input circuit breaker to reset and resume operation.



**Info:** While in Charger mode, the inverter's AC input breaker could nuisance trip if the loads on the inverter's AC HOT OUT 1 exceed the current rating of this circuit breaker.

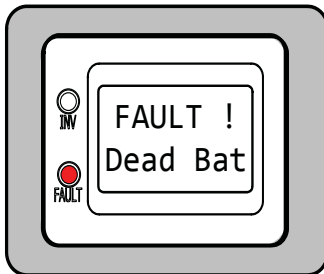

**Dead Bat** appears on the LCD and the FAULT (red) LED is on. The INV (green) LED is off.

*Figure 5-19, Dead Battery Charge Fault*

- **Dead Battery Charge Fault** – This fault has detected a very discharged battery bank, or a battery bank not connected to the inverter. The unit is attempting to enter the Charge mode, but has detected less than 9 volts (12-volt models), 18 volts (for 24-volt models), or 36 volts (for 48-volt models) on the battery bank.



**Remedy:** Check the DC voltage on the inverter's DC terminals and compare it with the DC voltage on the battery bank. These two voltages should be very close (<0.5 VDC difference). If not, check to ensure all connections are tight and the fuse/circuit breaker between the inverter and battery bank is good.

This fault automatically clears when the voltage is greater than 12.6 volts (12-volt models), 25.2 volts (24-volt models), or 50.4 volts (48-volt models) as detected by the inverter.

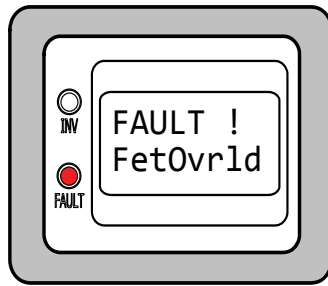

**FetOvrld** appears on the LCD and the FAULT (red) LED is on. The INV (green) LED is off.

*Figure 5-20, FET Overload Fault*

- **FET Overload Fault** – The inverter/charger has shut down because the internal FETs (Field Effect Transistors) have quickly exceeded a safe operating temperature. Once the FETs have cooled, perform a manual restart.



**Remedy:** If the fault continues to occur, disconnect all the inverter's AC output wires and reset the inverter (see Section 6.2). If this fault does not clear after doing a reset, the inverter may require service.

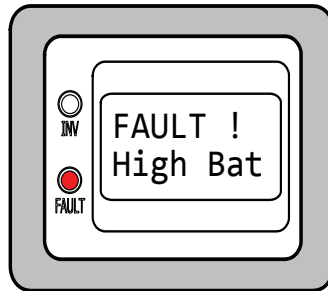

**High Bat** appears on the LCD and the FAULT (red) LED is on. The INV (green) LED is off.

*Figure 5-21, High Battery Fault*

- **High Battery Fault** – The inverter turned off because the battery voltage is above the High Battery Cut-Out (HBCO) value. The inverter automatically restarts and resumes operation when the battery voltage drops 0.3 VDC (12-volt models), 0.6 VDC (24-volt models), or 1.2 VDC (48-volt models) below the HBCO value. The HBCO value is dependent on your inverter revision and model.



**Remedy:** This fault usually occurs when an external DC source is charging the inverter's battery bank. Turn off any other additional charging source to allow the DC voltage level to drop.

## 5.0 Operation

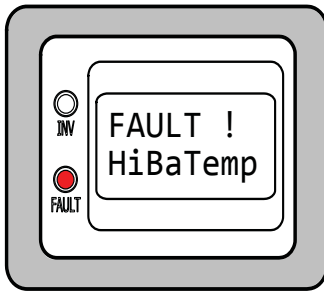

**HiBaTemp** appears on the LCD and the FAULT (red) LED is on. The INV (green) LED is off.

*Figure 5-22, High Battery Temp Fault*

- **High Battery Temp Fault** – This fault message indicates the inverter/charger has shut down because the Battery Temperature Sensor (BTS) has reached a temperature greater than 54°C/129°F.



**Remedy:** Once the BTS cools down ( $\leq 49^{\circ}\text{C}/120^{\circ}\text{F}$ ), it automatically restarts and continues operation. As a precaution, check the BTS location; if placed on a battery, ensure they are not overheated, or that the BTS has not been placed in a hot area or near a hot device. If neither of these are the issue, then monitor the BTS display under the *TECH: Bat Temp* menu—this reading should be above 54°C/129°F. Now remove the BTS from the inverter's BTS port. If the BTS reading goes to 25°C/77°F, replace the BTS. If the reading does not go to 25°C/77°F, then inspect the BTS port for cleanliness and/or have the inverter/charger serviced.

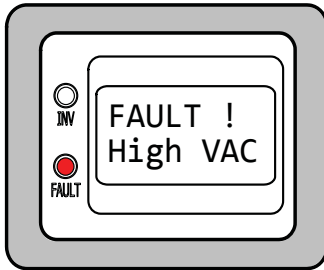

**High VAC** appears on the LCD and the FAULT (red) LED is on. The INV (green) LED is off.

*Figure 5-23, High Volts AC Fault*

- **High Volts AC Fault** – Charger is disabled due to a very high AC voltage ( $>150\text{ VAC}$ ,  $>260\text{ VAC}$  – export models) detected on the AC input.



**Remedy:** Remove all AC power from the inverter's AC input for at least 15 minutes to automatically restart this fault. Ensure only 120 VAC power is connected to each of the inverter's AC inputs. Check and correct the high voltage problem from the source.

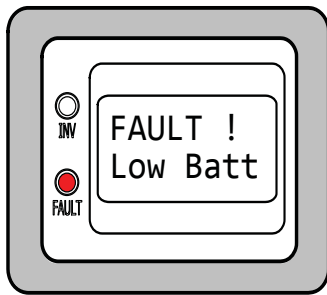

**Low Batt** appears on the LCD and the FAULT (red) LED is on. The INV (green) LED is off.

*Figure 5-24, Low Battery Fault*

- **Low Battery Fault** – The inverter turned off to prevent the batteries from being over-discharged. This fault message occurs when the battery voltage drops below the *LBCO* setting for more than one minute.



**Remedy:** This fault clears and the inverter automatically will restart and resume operation after one of the following conditions: 1. If the battery voltage rises to the inverters *LBCI* level (see Section 3.3.6); or, 2. If AC power is connected to the inverter's input and battery charging begins.

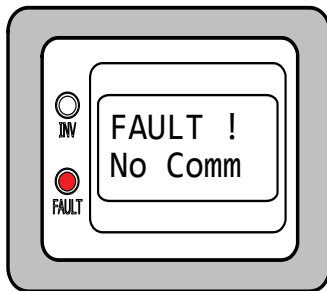

**No Comm** appears on the LCD. FAULT (red) LED is on. INV (green) LED may be off or on. Ignore the INV LED.

*Figure 5-25, No Communication*

- **No Comm** – Remote is not receiving any information from the inverter.



**Remedy:** Reset the remote by disconnecting the remote communications cable from the inverter for 5 seconds, and then reconnect it (see Figure 2-3). If the fault continues, first check/replace the remote cable. This cable is 4-wire telephone cable.

### What if the cable is not the issue?

- Try another remote display.
- Disconnect the remote from the Remote port and connect to the Network port.
- The inverter might need servicing.



## 5.0 Operation

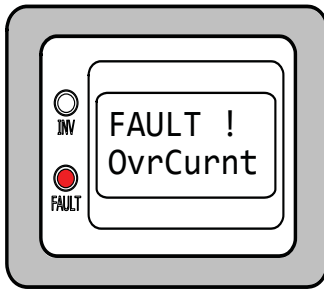

**OvrCurnt** appears on the LCD and the FAULT (red) LED is on. The INV (green) LED is off.

*Figure 5-26, Overcurrent Fault*

- **DC Overload Fault** – The inverter shuts down to protect internal power components from an excessive AC load. If the overload condition lasts for less than 10 seconds, the unit automatically restarts and resumes operation. However, if the overcurrent condition occurs for more than 10 seconds, the unit shuts down and requires a manual restart.



**Remedy:** This fault occurs because: the connected AC loads exceed the inverter's output capacity, there is a wiring short on the AC output, or the wires are incorrectly installed. Once the AC loads are reduced or the output wiring is corrected, manually restart the inverter. If this fault continues after all these recommendations, perform an inverter reset (see Section 6.2).

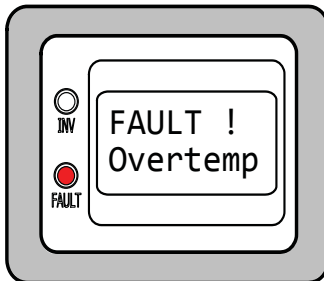

**Overtemp** appears on the LCD and the FAULT (red) LED is on. The INV (green) LED is off.

*Figure 5-27, Overtemp Fault*

- **Overtemp Fault** – The inverter/charger has shut down because the internal power components (FETs and/or transformer) have exceeded their safe temperature operating range. Once the unit cools down it automatically restarts and continues operation.



**Remedy:** If the fault occurs while inverting, reduce the load on the inverter. If it occurs while charging, turn down the charge rate. If this fault happens often, ensure the inverter is not in a hot area, has proper ventilation, and the cooling fans inside the inverter are working.

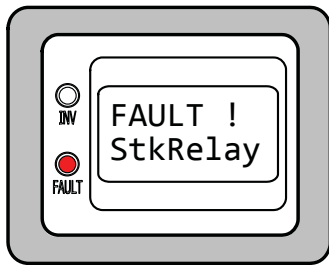

**StkRelay** appears on the LCD and the FAULT (red) LED is on. The INV (green) LED is off.

**Figure 5-28, Stuck Relay Fault**

- **Stuck Relay Fault** – This fault message displays when the internal AC pass-thru relay—that should be open while inverting—is closed.



**Remedy:** The AC pass-thru relay is most likely stuck because of damage to the contacts from trying to handle currents greater than their rating. This is usually caused by not protecting the relay from handling high continuous currents, or by switching high current inductive loads. The internal relay contacts are rated to handle 30 amps AC continuously and should be protected with a breaker sized no larger than 30 amps. If you are connected to an AC source (grid or generator) and running large inductive loads (i.e., pumps, motors, etc.,) on the inverter output, turn those particular loads off prior to removing the AC input source. This fault requires an inverter or power reset (Sections 6.2 & 6.3) to clear.

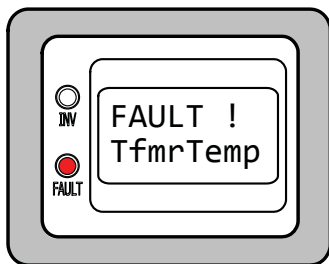

**TfmrTemp** appears on the LCD and the FAULT (red) LED is on. The INV (green) LED is off.

**Figure 5-29, Tfmr Overtemp Fault**

- **Transformer Overtemp Fault** – This fault message is displayed when the TCO (Temperature Cut-Out) opens and causes the inverter to shut down to protect the internal power transformer from damage. When the TCO has cooled down, the inverter will automatically restart and resume operation.



**Remedy:** If this fault occurs while inverting, reduce the load on the inverter. If it occurs while charging, turn down the charge rate. If it occurs often, ensure the inverter is in a cool location, has adequate ventilation, and the internal cooling fans are operational.

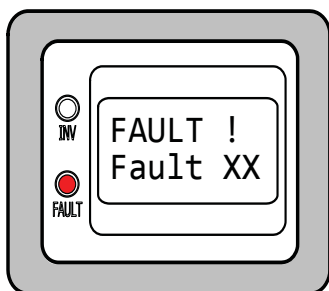

**Fault XX** appears on the LCD and the FAULT (red) LED is on. The INV (green) LED is off.

**Note:** XXs are just placeholders for the actual characters that appear.

**Figure 5-30, Unknown Fault**

- **Unknown Fault** – When a number appears in the second line of the remote it means the remote doesn't know what fault the inverter is reporting. Contact Magnum Technical Support for assistance with this fault.

## 5.0 Operation

### 5.3.3.2 Stacking Fault Messages

A fault condition may occur when multiple inverters are connected together (i.e., stacked)—that is not possible on a single inverter installation.

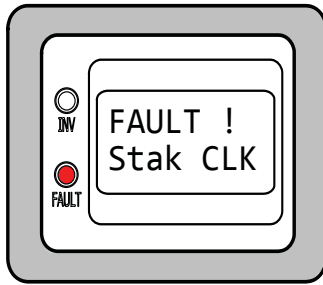

**Stak CLK** appears on the LCD and the FAULT (red) LED is on. The INV (green) LED is off.

*Figure 5-31, Stack Clock Fault*

- **Stack Clock Fault** – There is a stacker cable problem, or one inverter is losing synchronization with the other inverter.



**Remedy:** 1) Ensure you are using a Magnum stacking cable (this is not a telephone/data cable, it is custom made). 2) Inspect the stacker cable and reconnect at both ends (ensure you hear an audible “click” from the connectors at both inverters).



**Info:** This fault may occur if an accessory is plugged into the Stack port, but the installation is not using multiple inverters in a stacked configuration. If this occurs, reset the inverter (see Section 6.2).

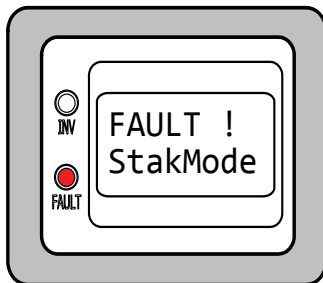

**StakMode** appears on the LCD and the FAULT (red) LED is on. The INV (green) LED is off.

*Figure 5-32, Stack Mode Fault*

- **Stack Mode Fault** – A problem with the ‘other’ stacked inverter has been detected, check that unit for a fault condition.



**Remedy:** This fault automatically clears when the fault with the other inverter is corrected.

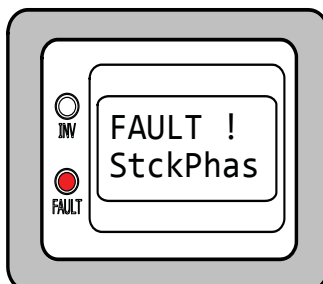

**StckPhas** appears on the LCD and the FAULT (red) LED is on. The INV (green) LED is off.

*Figure 5-33, Stack Phase Fault*

- **Stack Phase Fault** – 1) AC input wiring is incorrect; or, 2) One phase was lost from AC input source; or, 3) One of the inverter’s internal transfer relays is bad; or, 4) The inverter’s AC input circuit breaker may be open.



**Remedy:** If this fault doesn’t clear after checking the above recommendations, perform an inverter reset (see Section 6.2).

### 5.3.3.3 Internal Fault Messages

The inverter continually monitors several internal components. If a condition inside the inverter occurs that does not allow proper operation, the inverter shuts down to protect itself. An inverter reset is required to clear these faults.



**Remedy:** Perform an inverter reset (see Section 6.2). After resetting the inverter, press the ON/OFF button to turn the inverter on and to verify the fault has cleared. If the internal fault remains, the inverter may require repair at an authorized service facility.

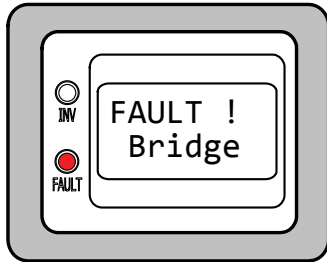

**Bridge** appears on the LCD and the FAULT (red) LED is on. The INV (green) LED is off.

*Figure 5-34, Internal Bridge Fault*

- **Internal Bridge Fault** – The inverter shuts down because the internal power-bridge protection circuit has been activated.

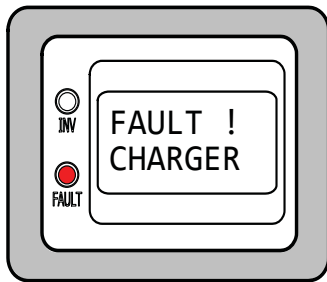

**CHARGER** appears on the LCD and the FAULT (red) LED is on. The INV (green) LED is off.

*Figure 5-35, Internal Charger Fault*

- **Internal Charger Fault** – The inverter shuts down because the internal charger protection circuit has been activated.

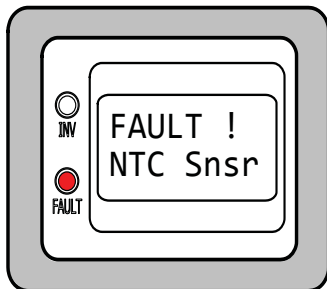

**NTC Snsr** appears on the LCD and the FAULT (red) LED is on. The INV (green) LED is off.

*Figure 5-36, Internal NTC Sensor Fault*

- **Internal NTC Sensor Fault** – The inverter shuts down because the internal NTC (temperature sensor) circuit has been activated.

## 5.0 Operation

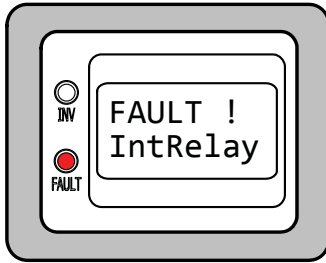

**IntRelay** appears on the LCD and the FAULT (red) LED is on. The INV (green) LED is off.

*Figure 5-37, Internal Relay Fault*

- **Internal Relay Fault** – The internal transfer relay is not closing even though the inverter is in Charge mode. Contact Magnum Technical Support (425-353-8833) for assistance.

### 5.3.4 LED Indicator Guide

The remote provides the following LED statuses. Use them along with the LCD display to determine the inverter/charger's operating status.

**Table 5-1, LED Indicator Guide**

LED	Status	Meaning
INV (green)	OFF	1) Inverter is disabled; or 2) Remote is in Power Saver mode – press any button to activate LEDs.
	ON	Inverter is enabled – 1) Supplying AC power on the output; or 2) In Standby (a charge status displays); the inverter will automatically supply AC power to the loads if shore or generator power is lost.
	BLINKING	Inverter is in Search mode (the AC load is below the <i>Search Watts</i> setting).
FAULT (red)	OFF	Normal operation.
	ON	A fault condition has been detected, check the LCD display to find and correct the cause.

### 6.0 Troubleshooting

If the remote is not functioning correctly, use the following table to help find a solution.

**Table 6-1, Remote Troubleshooting**

Symptom	Possible Cause	Solution
Display shows unrecognizable letters or symbols.	Static electricity may have been discharged into the LCD display.	Refresh display: Press and hold the MENU/HOME button for 10 seconds.
The LCD text display is locked-up, pressing any button has no response – may show “revision” or “connecting”.	The RJ11 connections on the communication cable are not making a good connection.	Reset remote: 1) disconnect the remote cable from the inverter for 5 seconds and then reconnect; 2) check RJ11 cable connection on back of the remote (see Figure 2-2). <b>Important:</b> Ensure the RJ11 connector is pushed into the correct port. You should feel/hear “click” when the connection is made.
	The remote is not getting sufficient power from the inverter.	Ensure the inverter batteries are connected and the inverter is operating correctly. The inverter should be able to invert and power AC loads from the batteries (ensure no AC power is connected to the inverter’s AC inputs).
The LEDs and the backlight are off.	The remote is in Power Saver mode.	Press any button to reactivate the remote (or turn the <i>Power Saver</i> setting to <i>Off</i> ).
The remote is non-functional (no lights, no text on LCD display, and no response when pressing any button).	The communication cable is bad or not correctly connected to the Remote port on the inverter.	Check the communications cable from the inverter to remote; ensure: 1) it is connected to the Remote port, 2) the correct communications cable is used (a 4-conductor telephone cable may be substituted to determine if cable is good).
	Inverter is not connected to batteries.	Ensure inverter batteries are connected and the inverter is operating correctly without any AC power connected (should be able to invert and power AC loads from batteries).

## 6.0 Troubleshooting

### 6.1 Troubleshooting Tips

#### 6.1.1 Inverter Problems:

- **Inverter turned on, the INV LED on the remote is blinking, no output:** Inverter is in Search mode. Either defeat Search mode—if not needed—or turn on loads greater than the *Search Watts* setting.

#### 6.1.2 Charger Problems:

- **Unit won't transfer to Charge mode with AC applied:** Measure the input AC voltage, it should be 120 VAC +/- 20 VAC, (export models: 230 VAC +/- 40 VAC). Also, check that the *VAC Dropout* setting on the remote is 80 VAC (150 VAC for export models) or less.

- **Transfer relay closes, and then opens and continues to cycle:** AC voltage is too low, or has transients that drop the AC voltage momentarily. Change the *VAC Dropout* setting to 60 VAC and check for improvements. If the cycling continues, back off the *Charge Rate* setting from 100% to 10%. This cycling may also occur if the AC output of the inverter is connected to the inverter's AC input—check for proper input and output AC wiring. Check the remote for indication of a fault.

- **Charger not charging even though the remote says "Charging":** Full charge rates are not obtained in Charge status, only after this mode changes to "Bulk", "Absorb," or "Float".

- **Charger not charging even though the remote says "Bulk" (or "Absorb"):** Check the DC amps meter and the DC voltmeter on the ME-MR display. It should be 80% or more of rated charge current if the battery voltage is under 14.0 VDC (28.0 VDC on 24-volt models or 48.0 VDC for 48-volt models). If not, check the *Charge Rate* setting and verify the setting is 80% or greater. Still low charge rate? Check the *AC IN* setting to verify the setting. If no AC loads are being passed through the inverter, the *AC IN* setting must be 15 amps (25 amps for 3kW unit) or greater, to receive a full charge rate.

- **Remote displays "Float" not "Bulk" when the AC is first plugged in:** Check DC volts on the ME-MR display, if the battery is over 13.0 VDC (26.0 VDC for 24-volt models or 52.0 VDC for 48-volt models) then the battery was already charged and the charger automatically goes to Float Charging to keep from overcharging the batteries.

- **Charge amps are lower than expected, or is 0 amps DC:** Measure input AC voltage and increase if the input voltage is under 90 VAC. The charge rate is reduced to try and keep the input voltage above 90 VAC; also check the *AC IN* and *Charge Rate* settings to determine if the current is being limited.

- **Charger output voltage is higher than expected:** Check the Battery Temperature Sensor (BTS) temperature. If the BTS is installed, the charge voltage settings will increase if the temperature around the BTS is below 77°F (25°C), and decrease if the temperature around the BTS is higher than 77°F (25°C).

### 6.2 Performing an Inverter Reset

To perform an inverter reset (i.e., soft reset):

1. Remove all AC power (utility or generator power) to the inverter.
2. Press and hold the inverter's Power ON/OFF pushbutton (see Figure 6-1) for approximately 15 seconds until the Charging/Inverting Status LED comes on and flashes rapidly.
3. Once the rapid flashing has begun, release the Power ON/OFF pushbutton. The Status LED will go off after the pushbutton is released.
4. Press the Power ON/OFF pushbutton to turn on the inverter.

Some older inverter models do not allow an inverter reset. If the inverter reset fails, perform a power reset using the procedure below. In either case, if an internal fault does not clear the inverter will require repair at an Authorized Service Center (ASC).



**Info:** The Power ON/OFF pushbutton is a small momentary type switch which operates by lightly pressing and releasing.



**Info:** All adjustable inverter/charger settings in the ME-MR are saved in non-volatile memory and are preserved until changed—even if an inverter reset is performed, or if all power to the remote or inverter is removed.



1. Ensure all AC power (i.e., shorepower or generator) is removed from the inverter's input.

2. Press and hold the Power ON/OFF pushbutton for 15 seconds.

3. Watch the Charging/Inverting Status LED, after approximately 15 seconds it should come on and flash rapidly to indicate the inverter has reset. The Status LED will go off after the pushbutton is released.

*Figure 6-1, Performing an Inverter Reset*

### 6.3 Performing a Power Reset

To perform a power reset (i.e., hard reset):

1. Remove all AC power (utility or generator power) to the inverter.
2. Open all the inverter DC disconnects (or disconnect the positive battery cable to the inverter).
3. Ensure the inverter and the remote are disconnected from all AC and DC power (the remote display will be blank).
4. After the inverter has been disconnected from all power for 30 seconds, reconnect the inverter disconnects (or reconnect the positive battery cable) and resume operation.



**Info:** If DC disconnects are not used, there may be a momentary spark when the positive battery cable is connected to the inverter's terminal. This is normal and indicates that the inverter's internal capacitors are being charged.



## 7.0 Warranty Information

### 7.0 Warranty Information

#### 7.1 Warranty Statement

Sensata Technologies (hereafter "Sensata") warrants the ME-MR remote to be free from defects in material and workmanship that result in product failure during normal usage, according to the following terms and conditions:

1. The limited warranty for this product extends for a maximum of 12 months from the product's original date of purchase.
2. The limited warranty extends to the original purchaser of the product and is not assignable or transferable to any subsequent purchaser.
3. During the limited warranty period, Sensata will repair or replace at our option any defective parts—or any parts that will not properly operate for their intended use—with factory new or remanufactured replacement items if such repair or replacement is needed because of product malfunction or failure during normal usage. The limited warranty does not cover defects in appearance, or cosmetic, decorative, structural or non-operative parts. Sensata's limit of liability under this warranty shall be the actual cash value of the product at the time the original purchaser returns the product for repair, determined by the price paid by the original purchaser. Sensata shall not be liable for any other losses or damages.
4. Upon request from Sensata, the original purchaser must prove the product's original date of purchase by a dated bill of sale, itemized receipt.
5. The original purchaser shall return the product prepaid to Sensata. After the completion of service under this limited warranty, Sensata will return the product prepaid to the original purchaser via a Sensata selected non-expedited surface freight within the contiguous United States and Canada; this excludes Alaska and Hawaii.
6. If Sensata repairs or replaces a product, its warranty continues for the remaining portion of the original warranty period or 90 days from the date of the return shipment to the original purchaser, whichever is greater. All replaced products and parts removed from repaired products become the property of Sensata.
7. This limited warranty is voided if:
  - the product has been modified without authorization.
  - the serial number has been altered or removed.
  - the product has been damaged from abuse, neglect, accident, high voltage or corrosion.
  - the product was not installed and operated according to the owner's manual.

#### 7.2 Warranty Service

If your product requires warranty service, contact Sensata Technologies at [MagnumWarranty@Sensata.com](mailto:MagnumWarranty@Sensata.com).

When returning your product directly to Sensata, you must:

1. Return the unit in the original, or equivalent, shipping container.
2. Receive a Return Materials Authorization (RMA) number from Sensata prior to the return of the product for service.
3. Place RMA numbers clearly on the shipping container or the packing slip.

When sending your product for service, please ensure it is properly packaged.

**Damage due to inadequate packaging is not covered under warranty.**

We recommend sending the product by traceable and insured service.

**BEFORE RETURNING ANY UNIT, A RETURN MATERIAL  
AUTHORIZATION (RMA) NUMBER IS REQUIRED**



Magnum Energy Products

*Manufactured by:*

**Sensata Technologies**

[www.SensataPower.com](http://www.SensataPower.com)



**Sensata**  
Technologies